

Válenda SENIOR 90

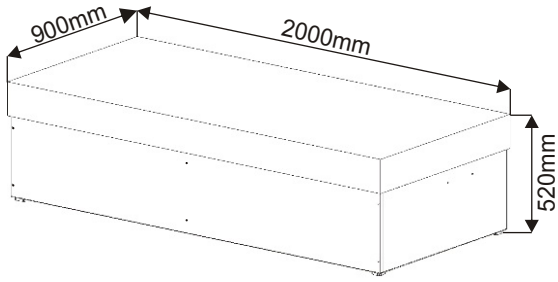

Kolík 35mm 12x 	Konfirmát 50mm 12x 	Pø 6,3 4x 	M6 somojistná 8x 	Hřebík 70x 	Mechanika pravá 1x levá 1x
Nálepky 12x 	Kluzák 4x 	Vratový šroub 6x30 4x 	Vrut 4x30 2x 	Pružina malá hrubá 2x 	Lepidlo

1.

Naklepeme kolíky 8x35mm do hrany.

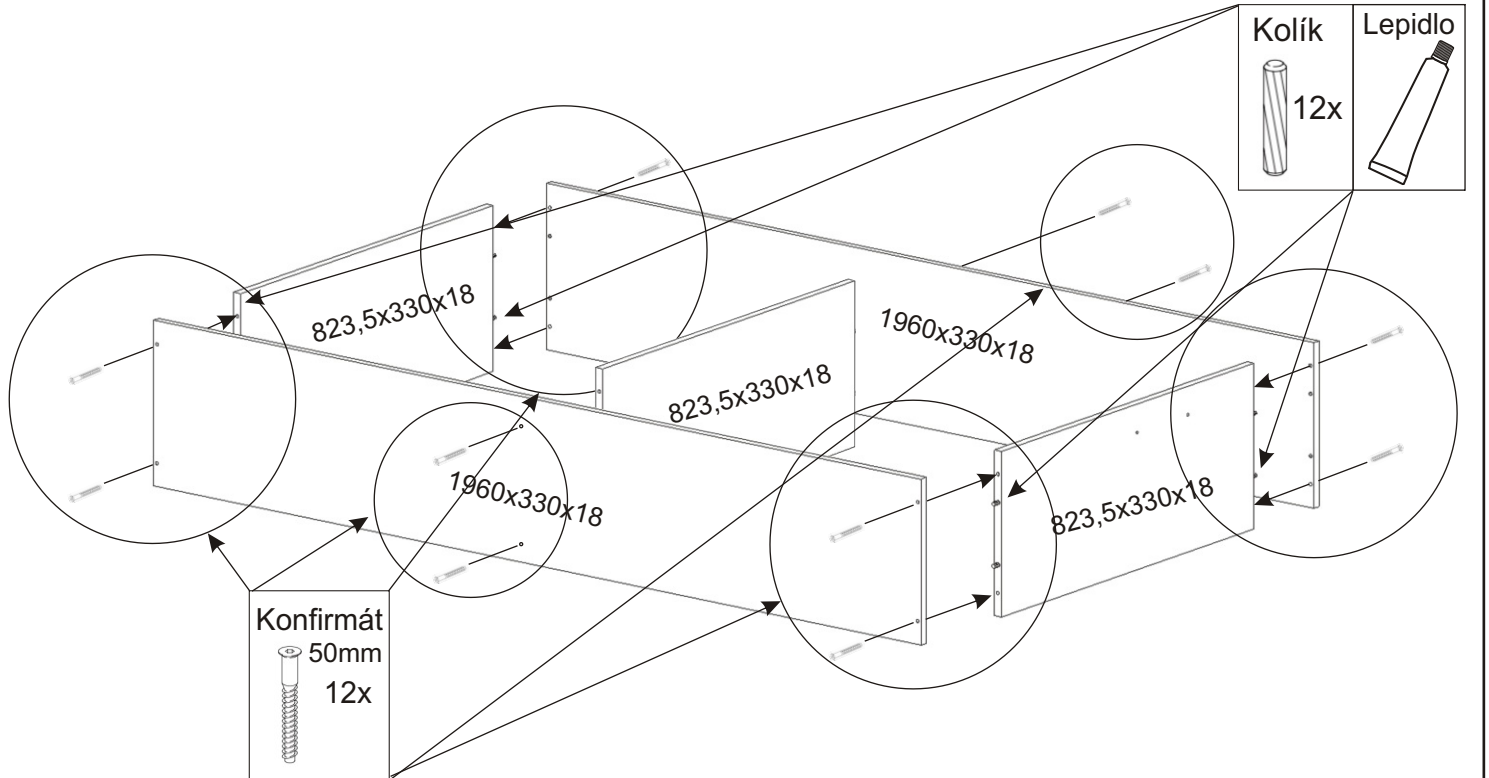

2.

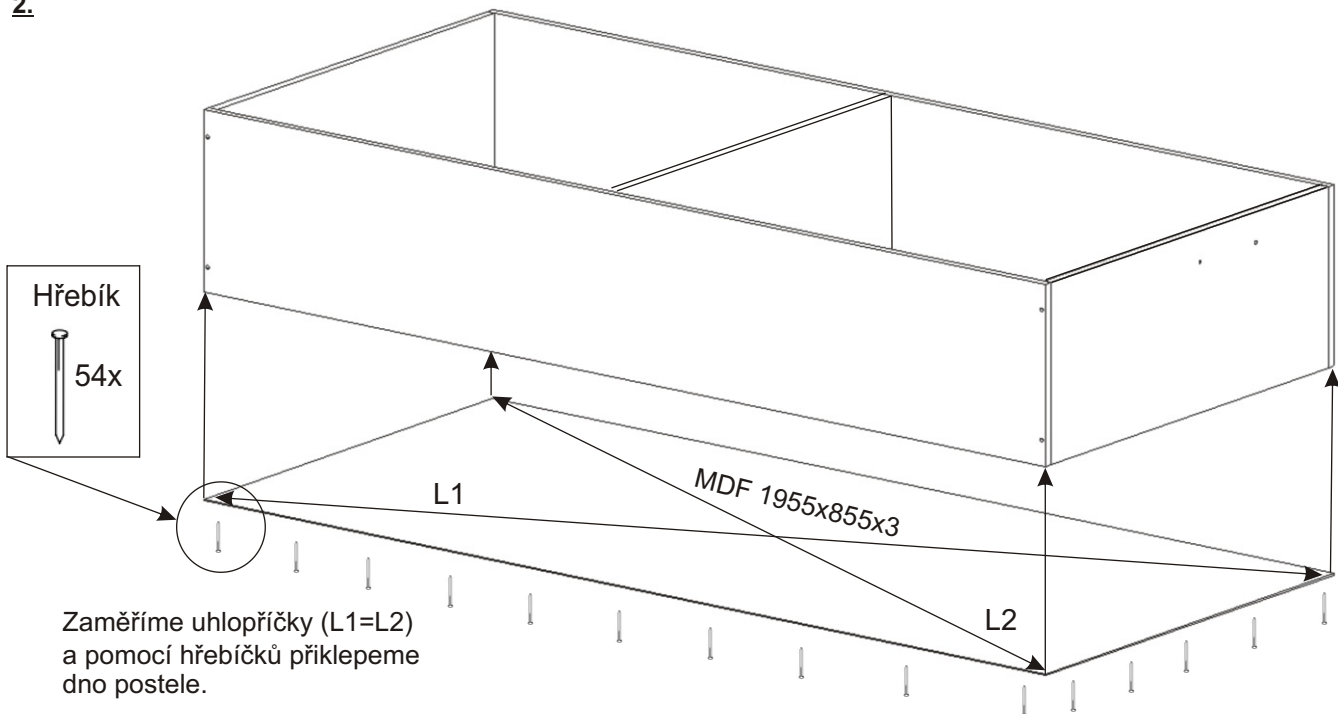

Zaměříme uhlopříčky (L1=L2) a pomocí hřebíčků přiklepeme dno postele.

3.

Na mechaniky nasadíme pelest válendy a pomocí matic M6 pelest sešroubujeme spolu s korpusem. Vše dotáhneme a zajistíme dvěma vruty V4x30. Pelest postele otevřeme dokořán a nasadíme na mechaniku pružiny-na každou stranu po jednom kuse.

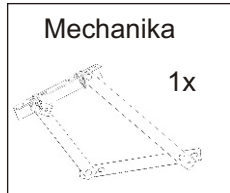

Pomocí vratových šroubů M6x35, podložky o 6mm a matice M6 přišroubujeme mechaniky.

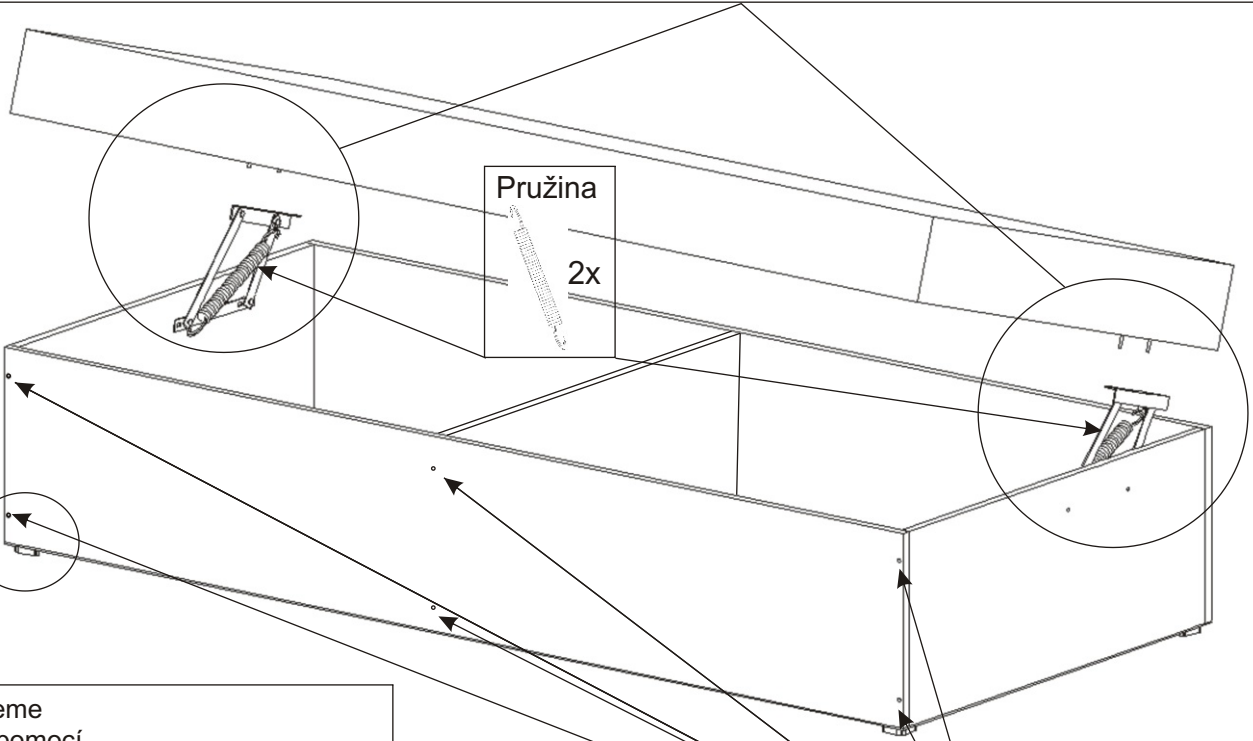
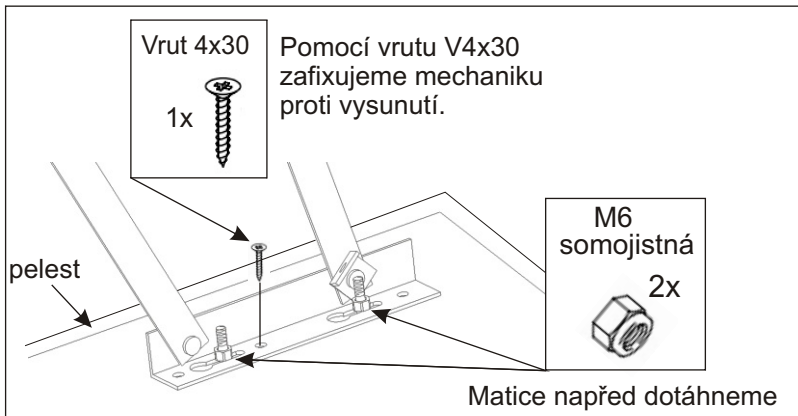
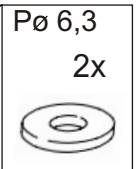

Do rohů přiklepeme rohové kluzáky pomocí 4ks hřebíků.

