

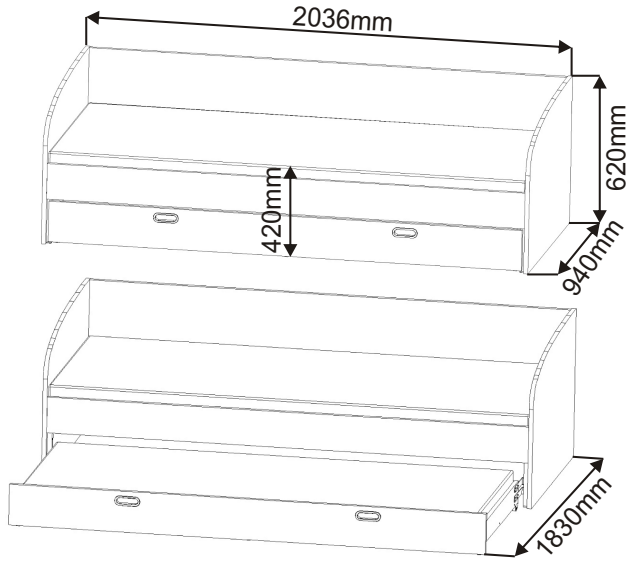













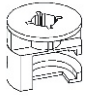

Válenda BIMBO s výsuvným lůžkem

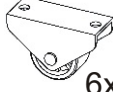
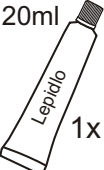
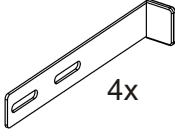

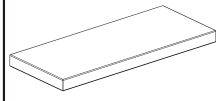
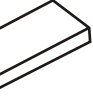
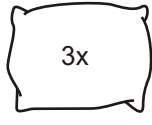
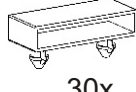
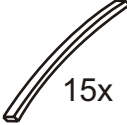
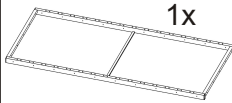
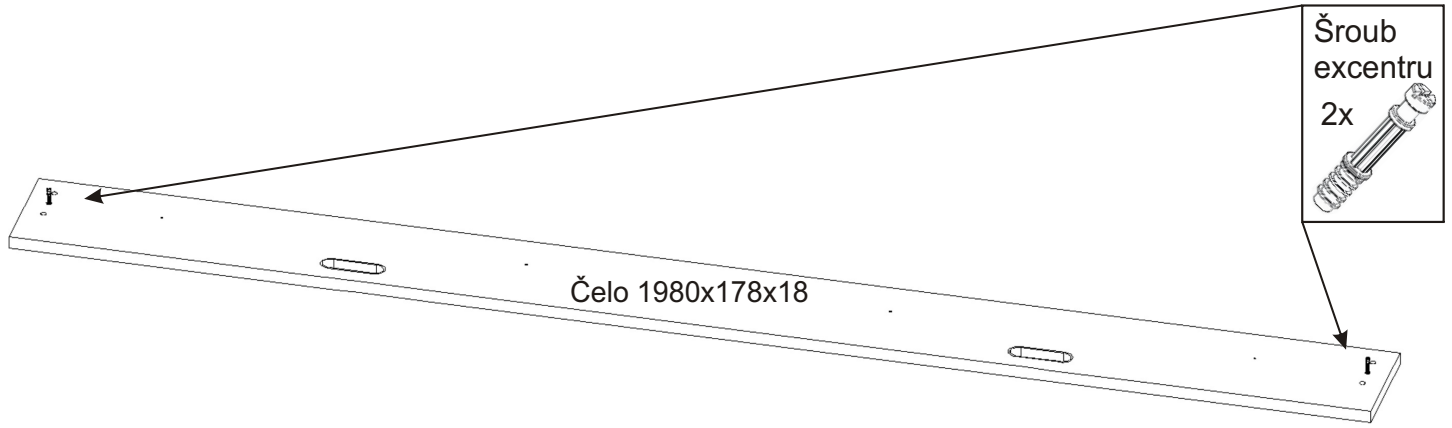

Vratový šroub M6x30 8x 	Matice M6 samojistná 8x 	Podložka M6 8x 	Konfirmát 50mm 22x 	Krytka 18x 	Kolík 35mm 14x 
Spojovací excentr 4x 	Šroub excentru 4x 	Excentr 6x 	Šroub excentru 6x 	Pojzdové kolečko v 31mm 6x 	Lepidlo 20ml 1x 
Dorazový prvek 167x24x28 4x 	Dorazový jekl s krytkou 200x20x20 2x 	Vrut 4x45 30x 	Vrut 4x35 4x 	Vrut 4x30 4x 	Vrut 4x20 12x 
Matrace 2000x900x150-1x 1900x800x120-1x 	Prostěradlo 2000x900 1x 	Polštáře 3x 	Držák lamel 30x 	Lamely 885mm 15x 	Pevný rám s krytkami 1998x898x50 1x 

1.

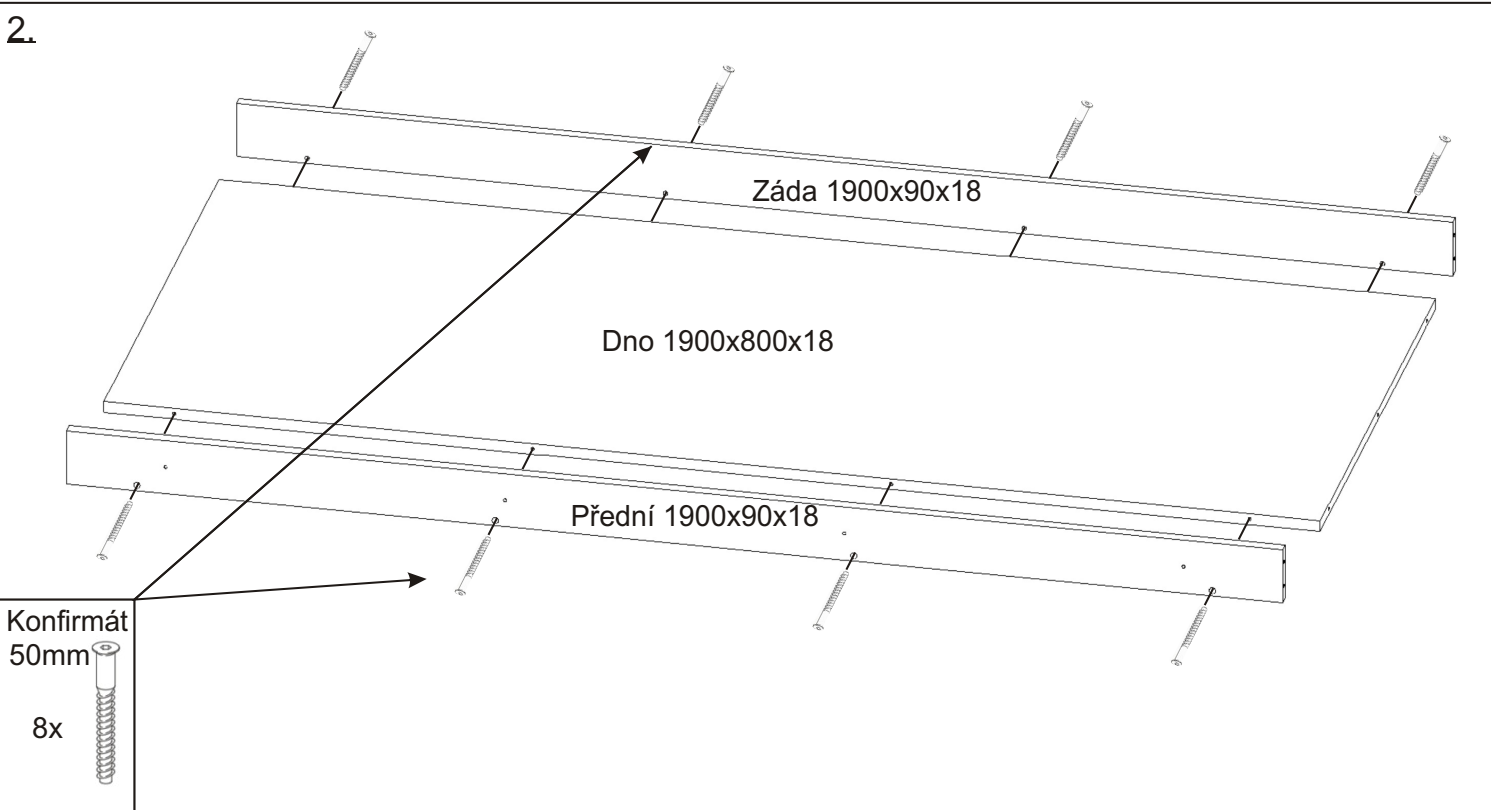

2.



Konfirmát 50mm
8x

3.

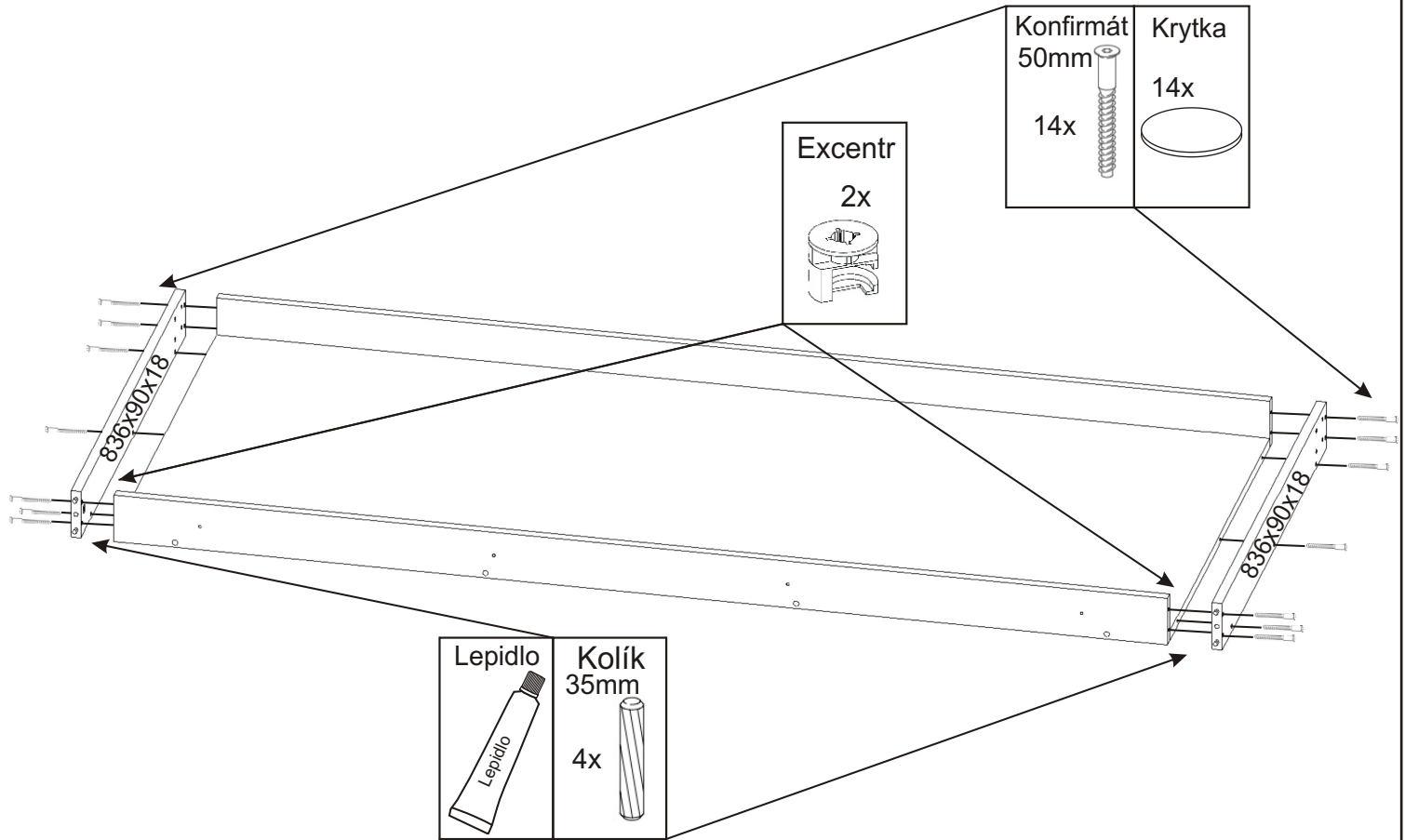

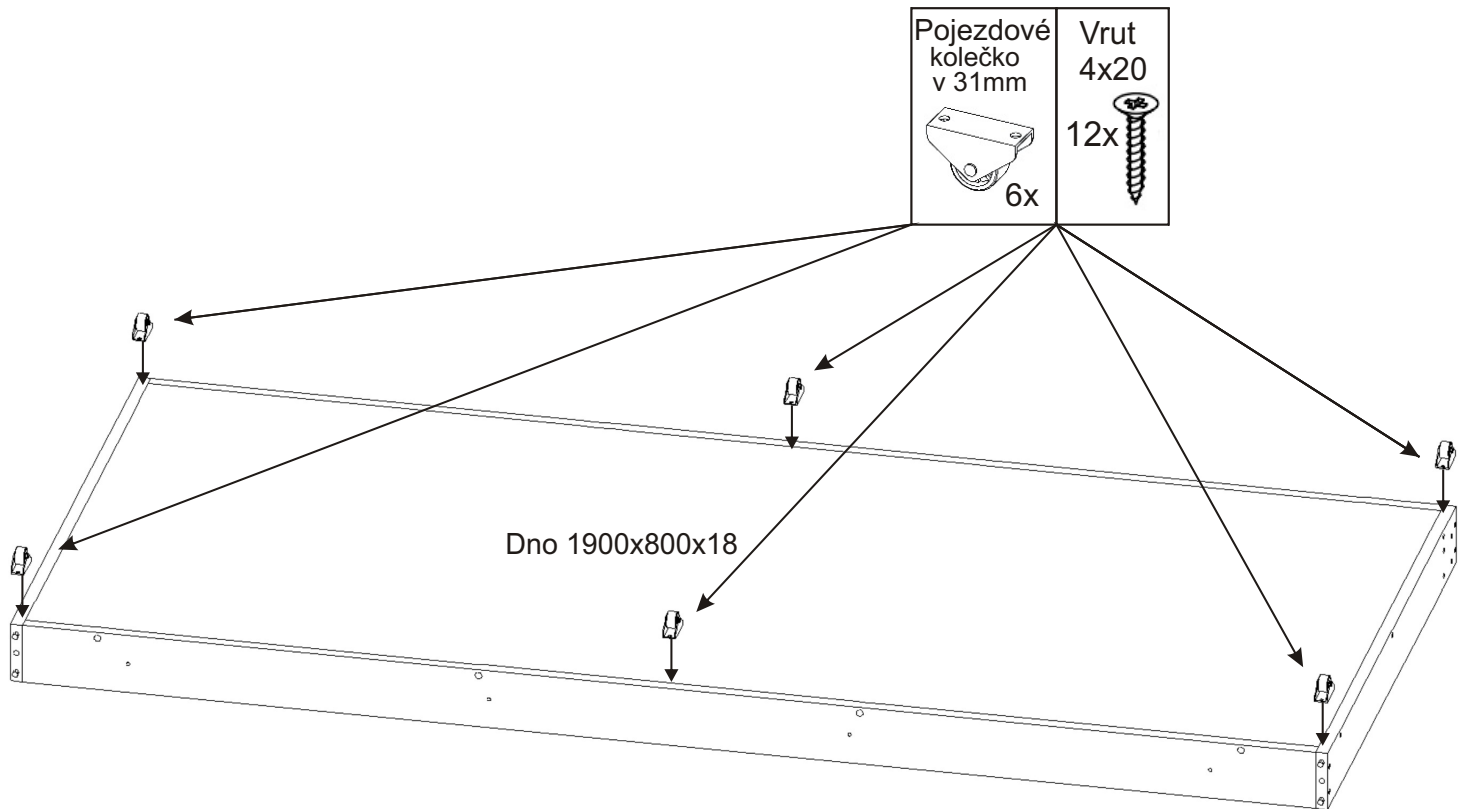

4.

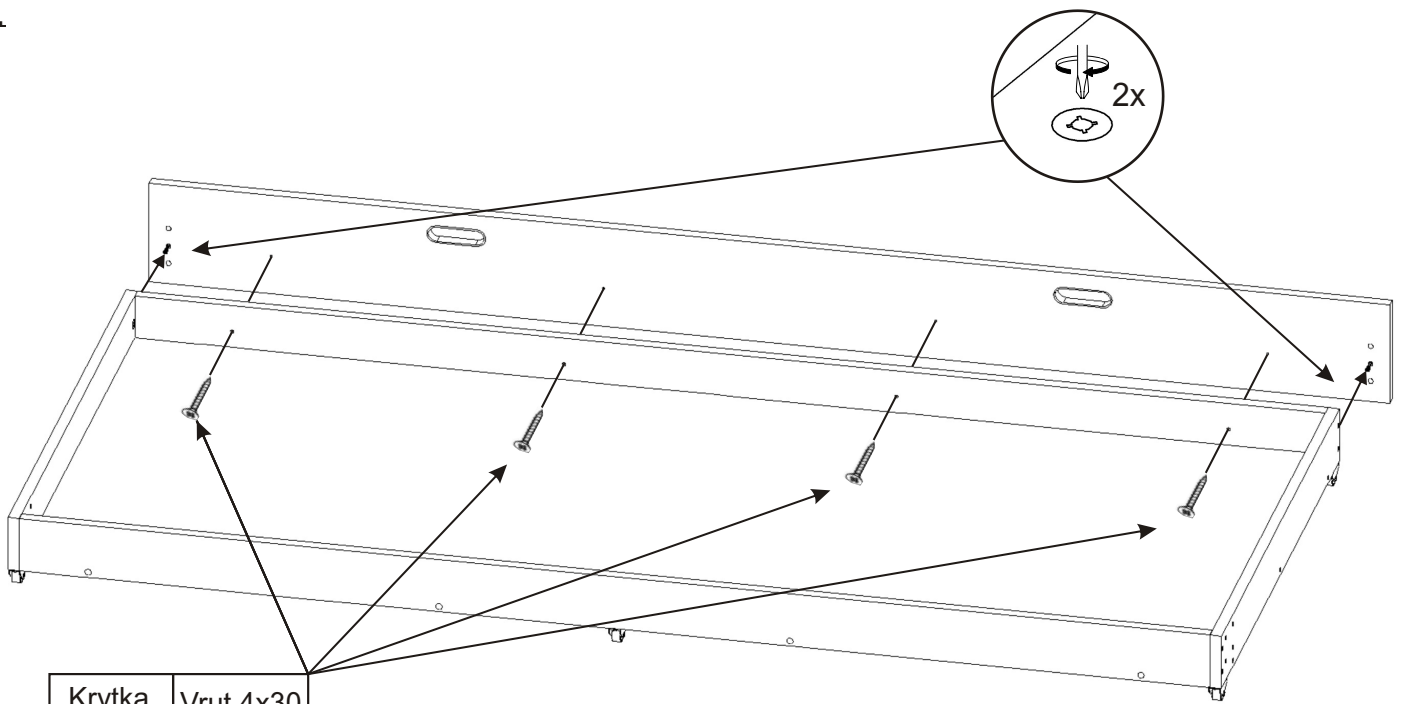

5.



Krytka 4x 	Vrut 4x30 4x 
---	--

6.

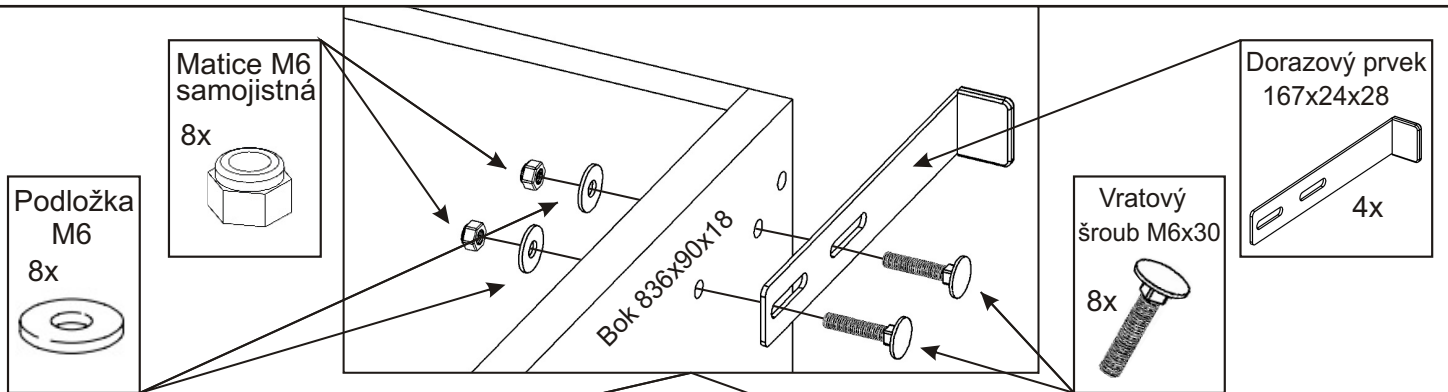

Podložka M6 8x 

Matice M6 samojistná 8x 
--

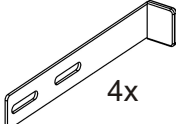
Dorazový prvek 167x24x28 4x 
--

Vratový šroub M6x30 8x 

Bok 836x90x18

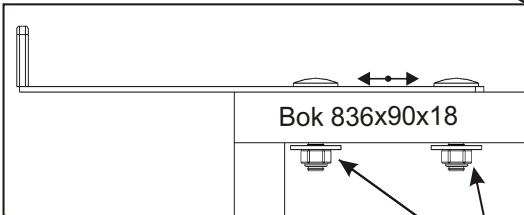
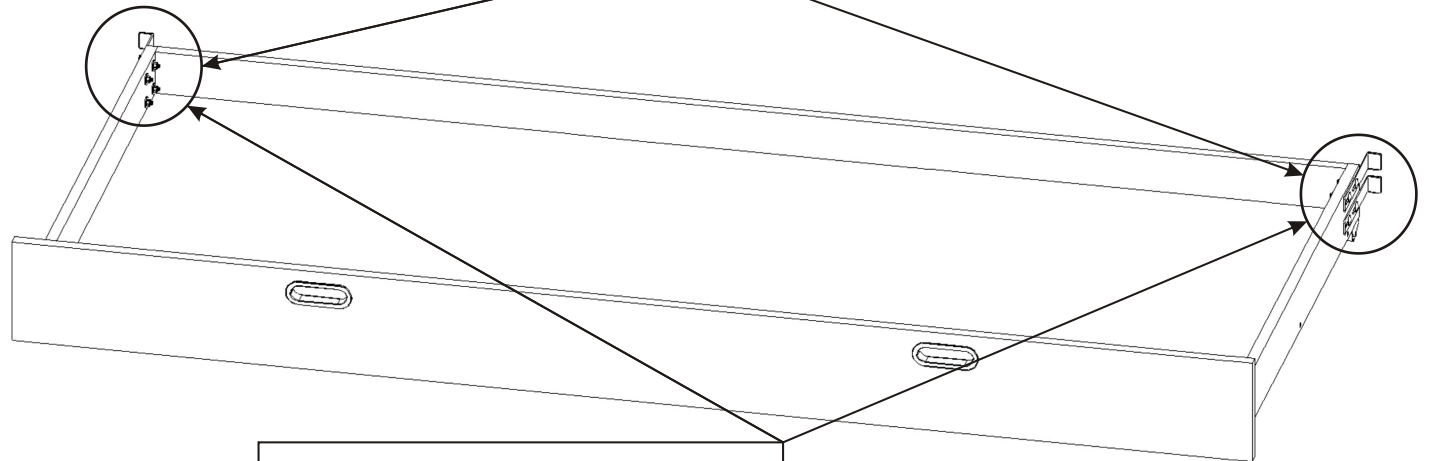

Samojistnou matici zcela nedotahujeme, jen tak, aby dorazový plech volně jezdil ve vratovém šroubu.

7.

Excentry je důležité naklepávat souběžně na jednu i druhou stranu, aby nedošlo k vylomení.

Spojovací excentr

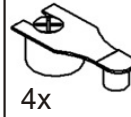

Lepidlo

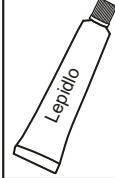

Kolík

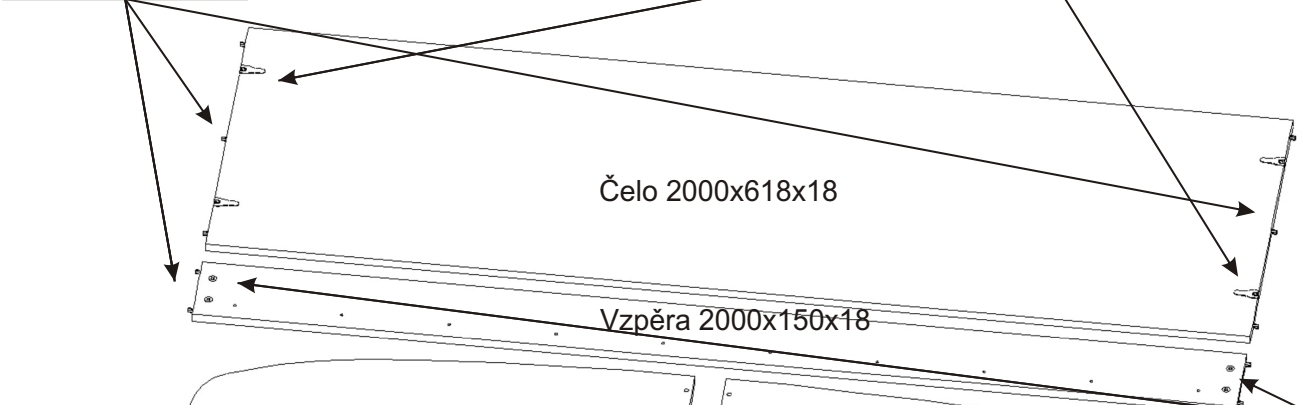
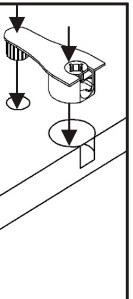
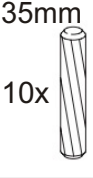

Excentr

4x

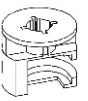

Šroub excentru

4x



Šroub excentru

4x



8.

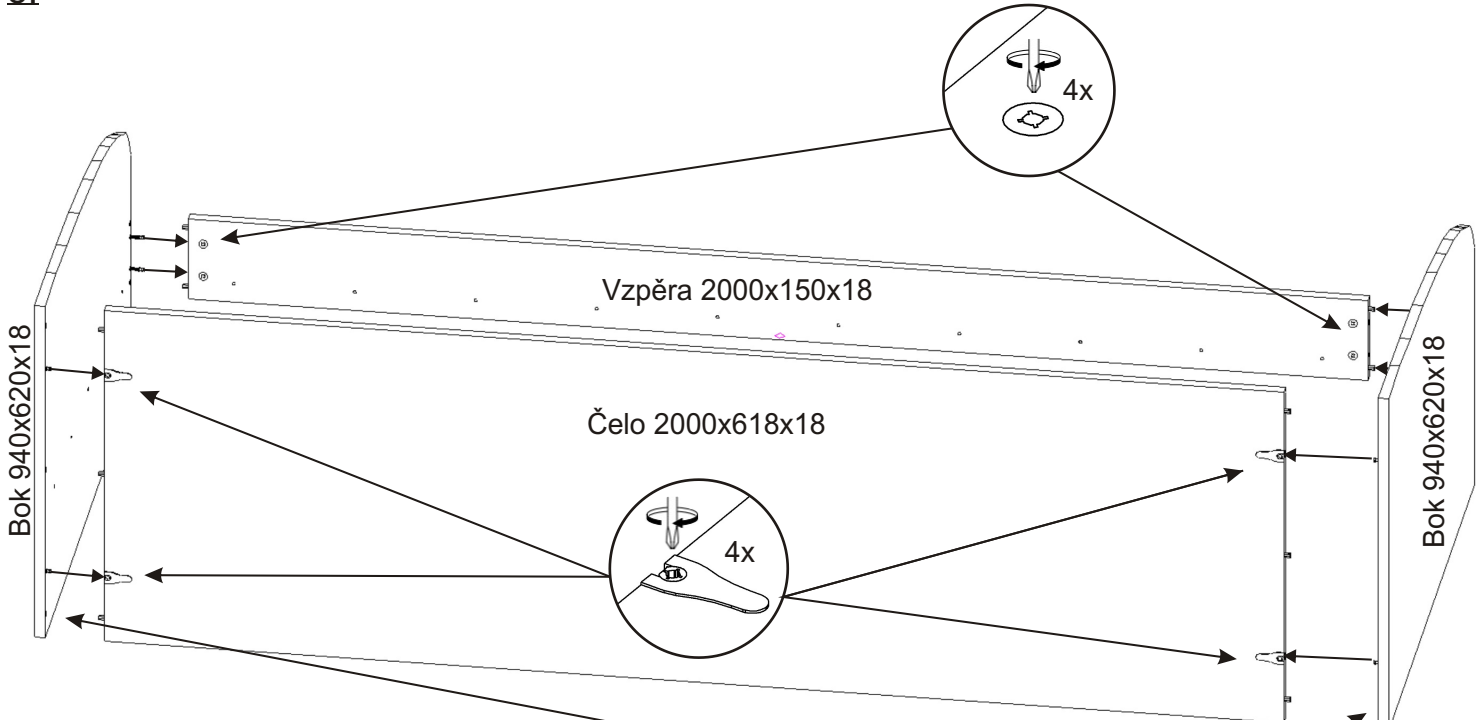

Lepidlo

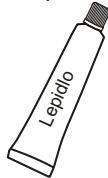

Pokud pohovku zalepíme lepidlem, už nebude možné ji rozebrat bez poškození.
Postel je možné složit i bez lepidla.

9.

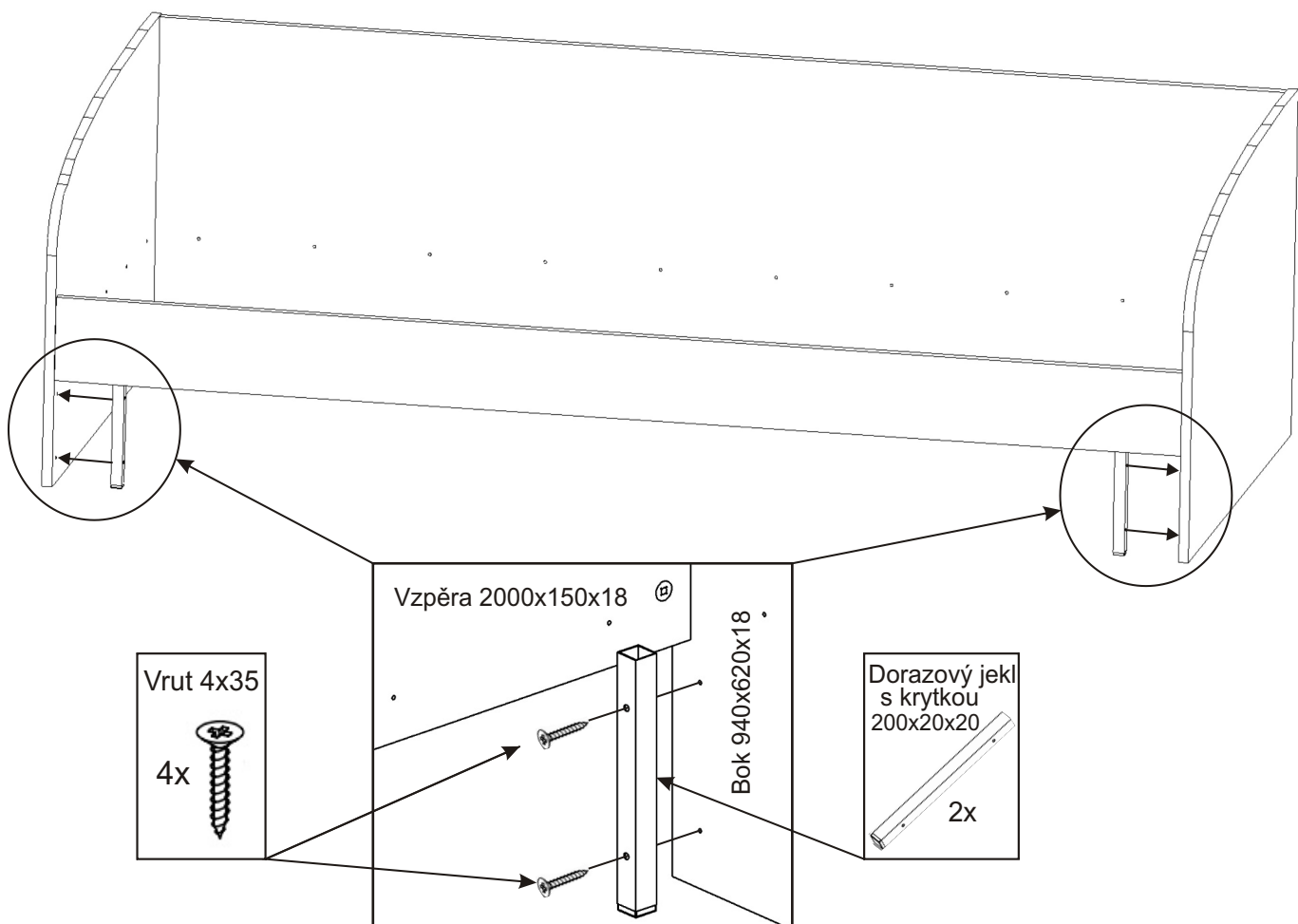

10.

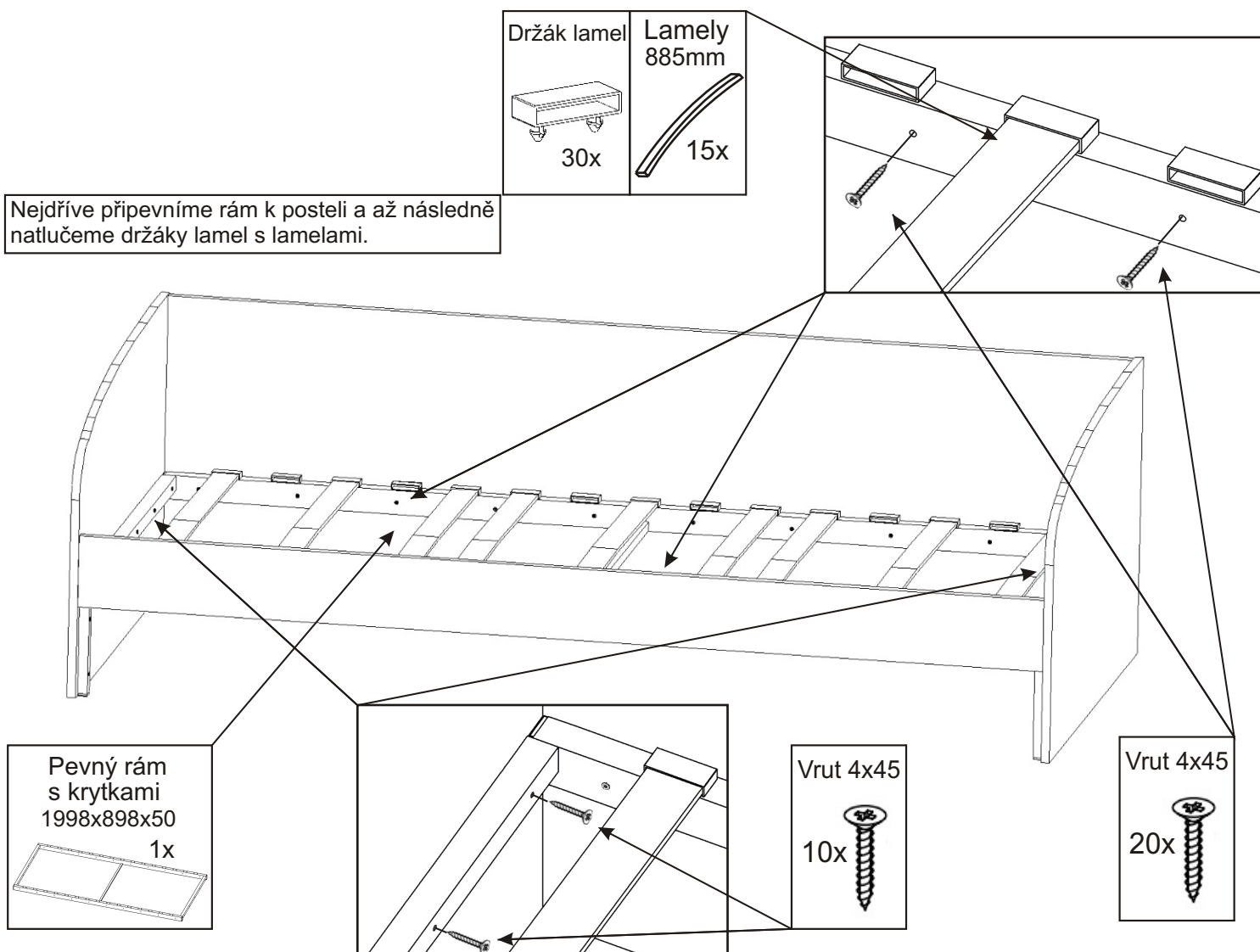

11.

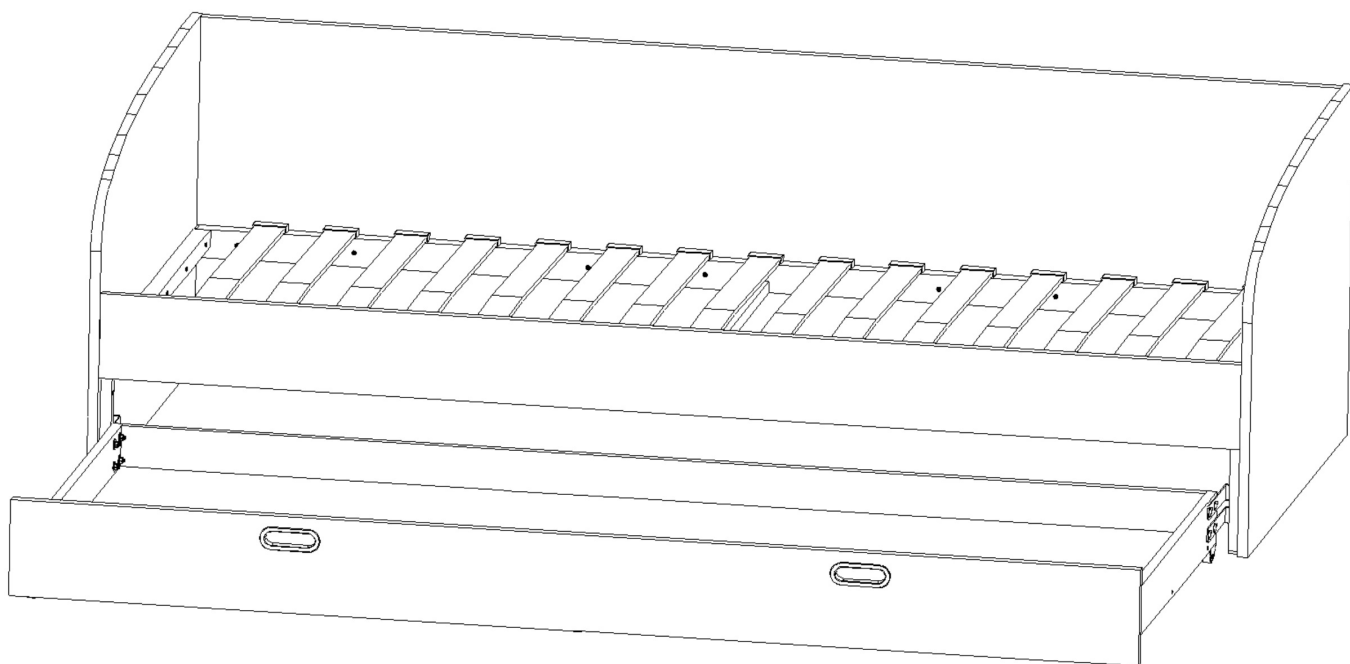

12.

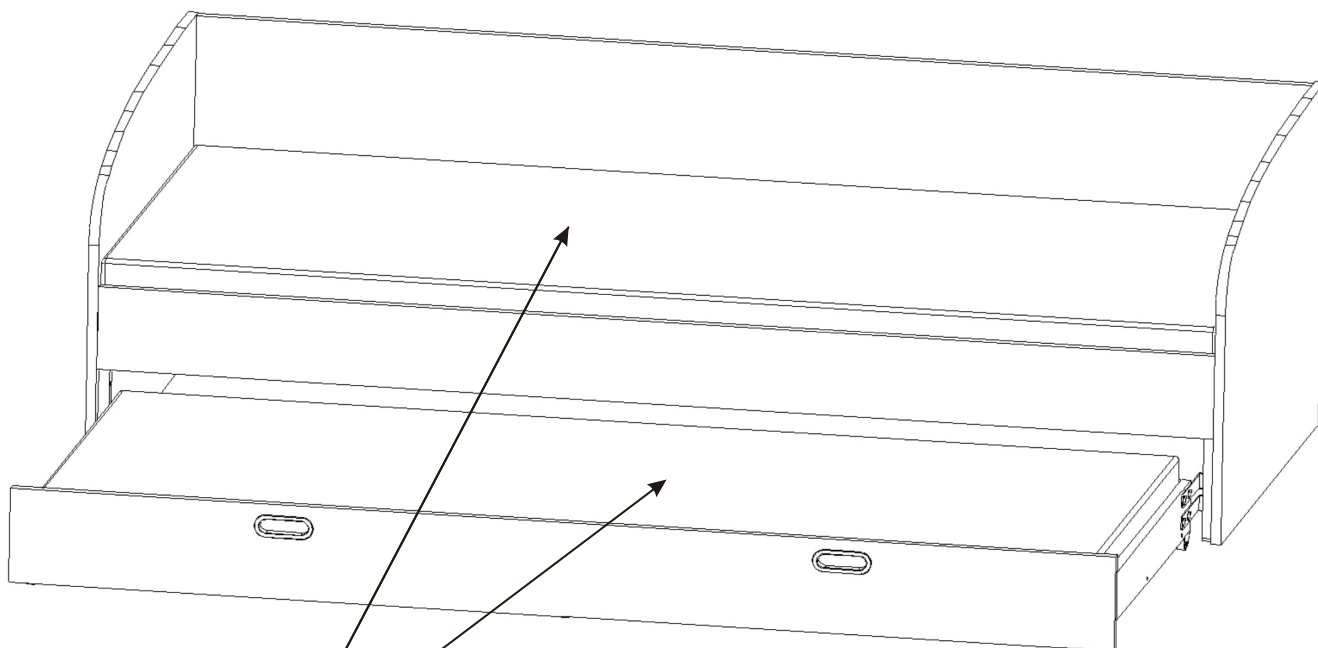

Do válendy vložíme matrace 2000x900x150 a 1900x800x120.
Následně navlékneme na matraci prostěradlo.