

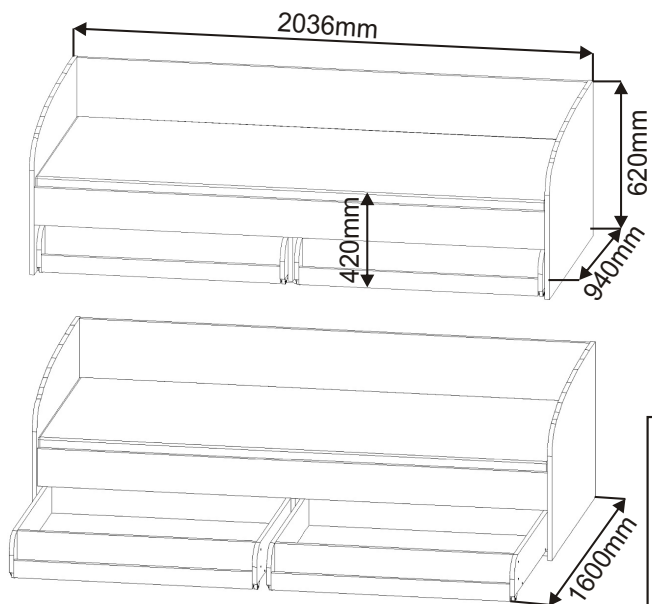

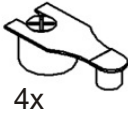

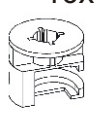



# Válenda BIMBO s úložným priestorom

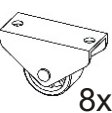
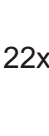
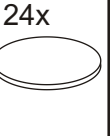

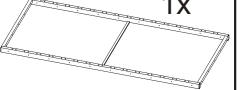
<b>Spojovací excentr</b>  4x	<b>Šroub excentru</b>  4x	<b>Excentr 16x</b>  16x	<b>Šroub excentru 16x</b>  16x	<b>Pojzdové kolečko v 31mm</b>  8x	<b>Konfirmát 50mm</b>  32x
<b>Kolík 35mm</b>  22x	<b>Lepidlo 20ml</b>  1x	<b>Krytka</b>  24x	<b>Vrut 4x45</b>  30x	<b>Vrut 4x20</b>  16x	<b>Pevný rám s krytkami 1998x898x50</b>  1x
<b>Prostěradlo 2000x900</b>  1x	<b>Polštáře</b>  3x	<b>Držák lamel</b>  30x	<b>Lamely 885mm</b>  15x	<b>Matrace 2000x900x150</b>  1x	

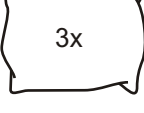
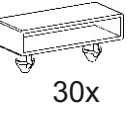
## 1.1. Montáž úložného priestoru 2ks

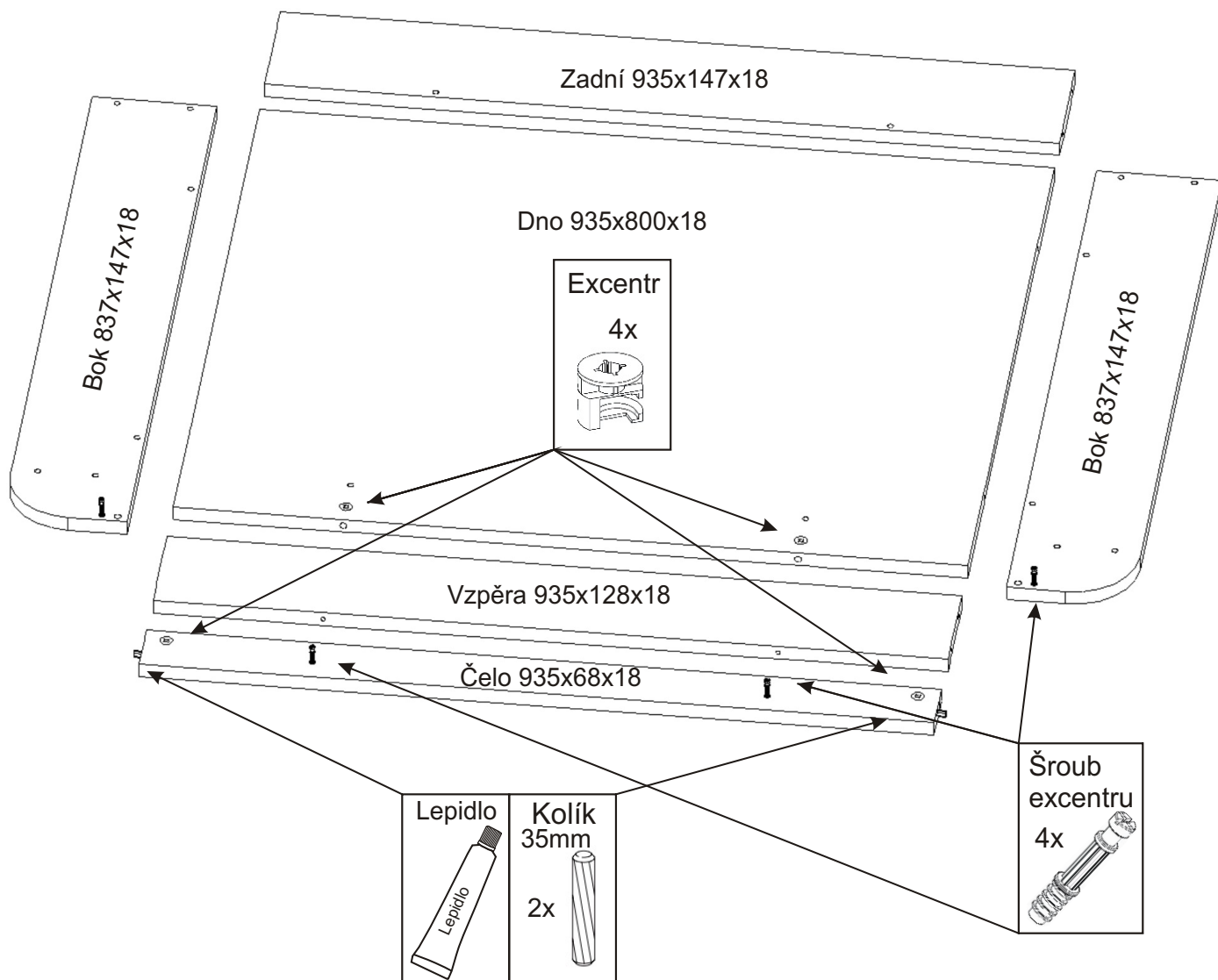

1.2.

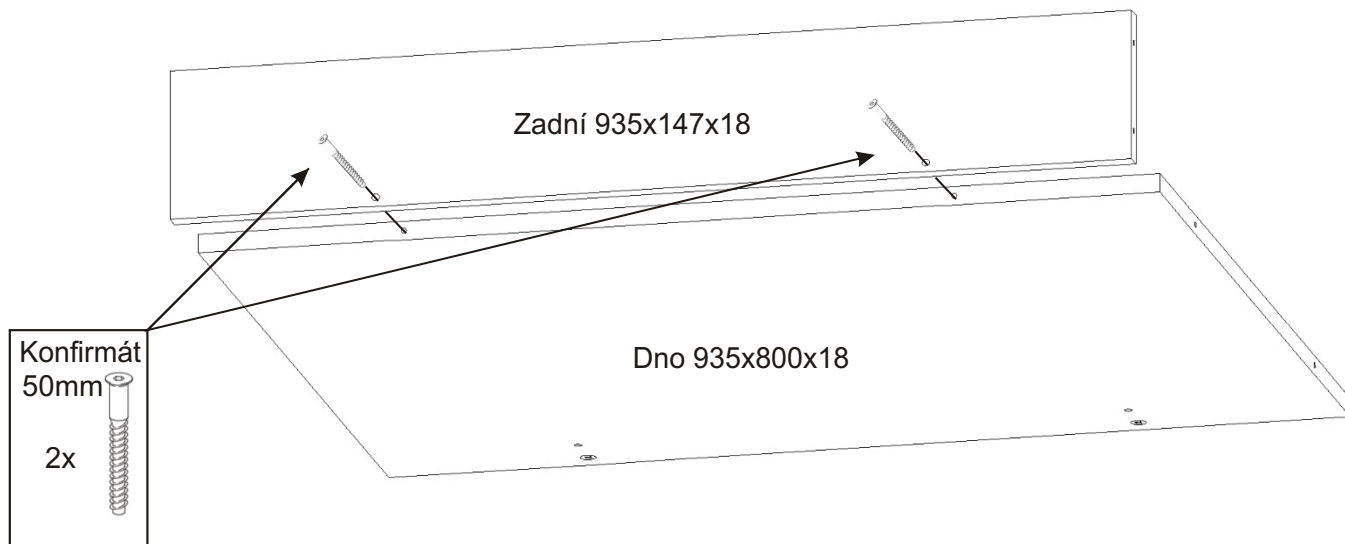

1.3.

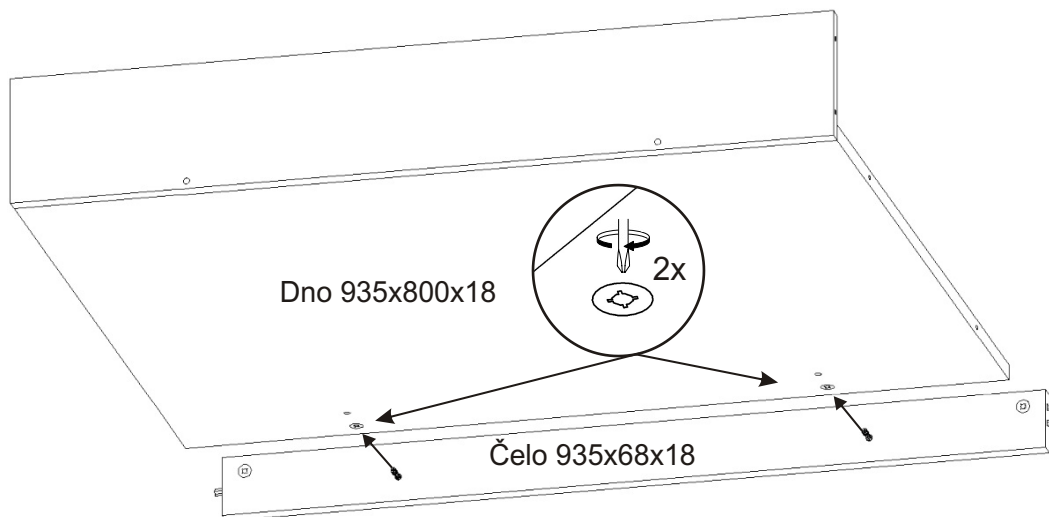

1.4.

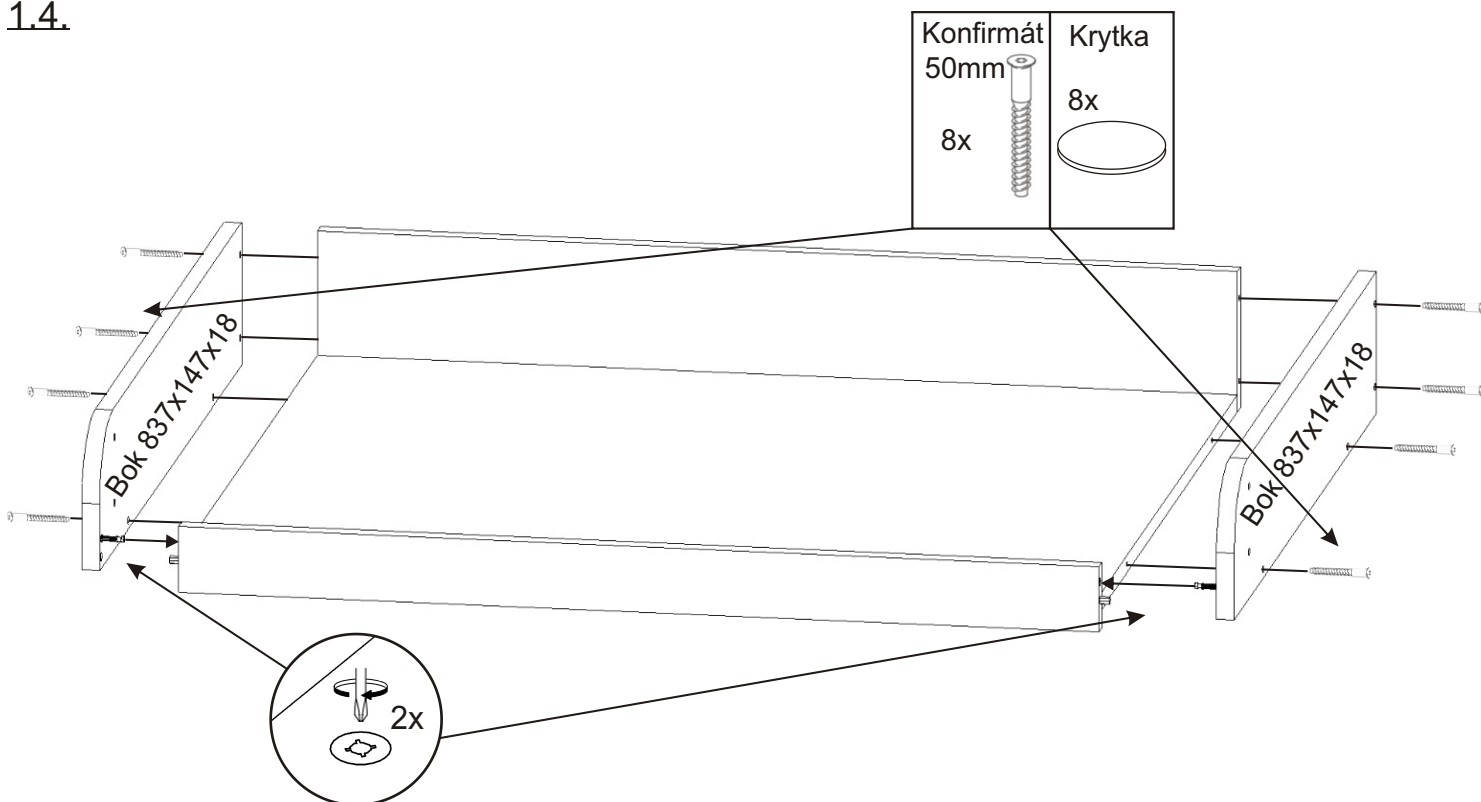

1.5.

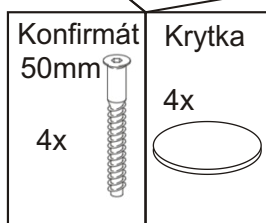
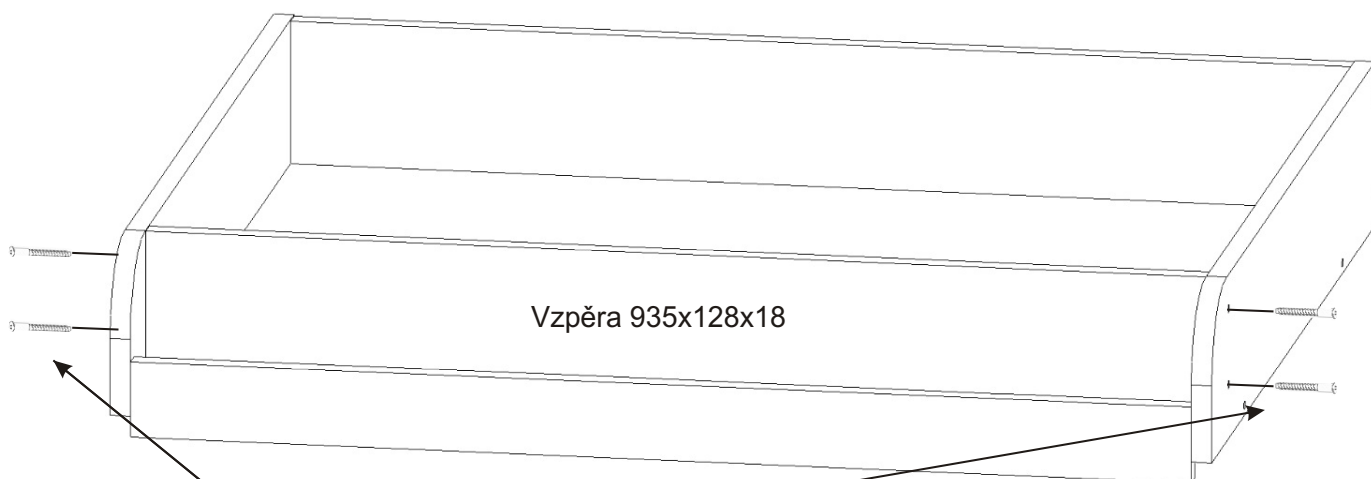

1.6.

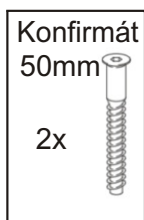
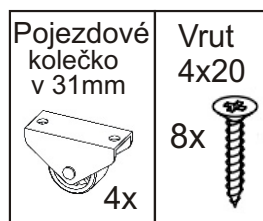
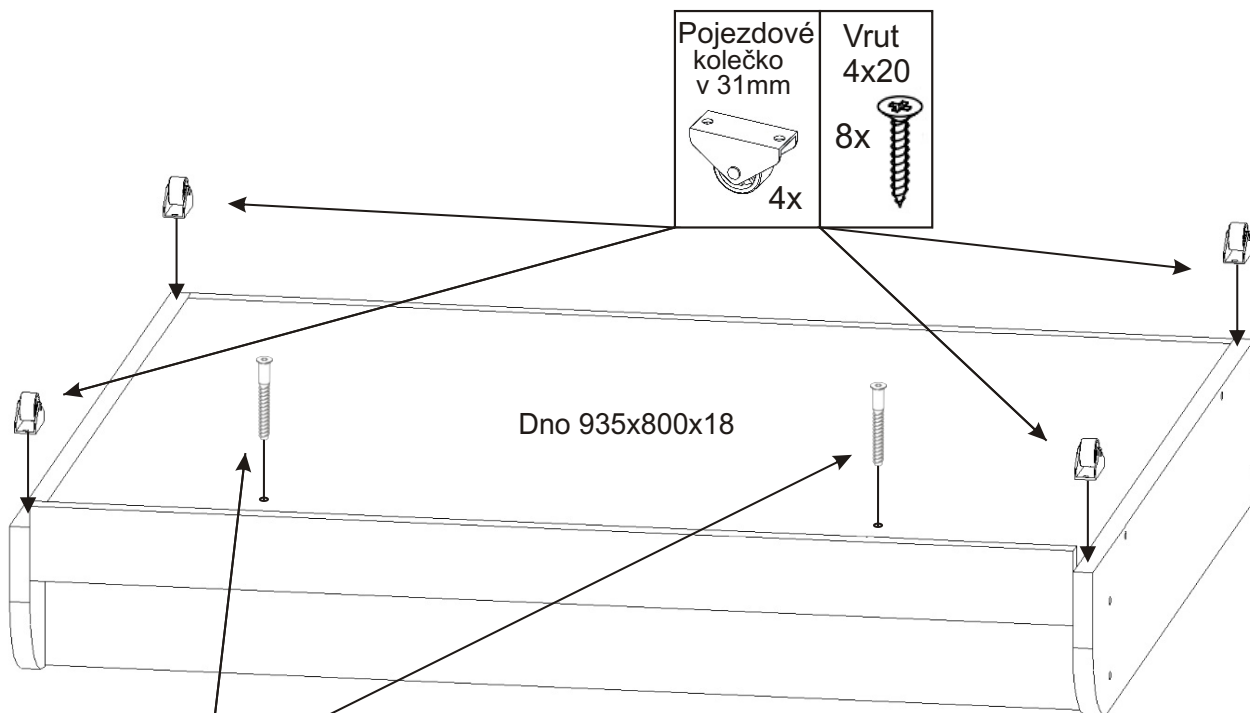

2.

Excentry je důležité naklepat souběžně na jednu i druhou stranu, aby nedošlo k vylomení.

Spojovací excentr

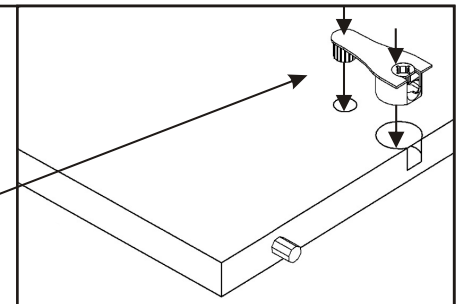
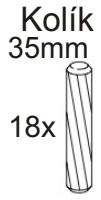
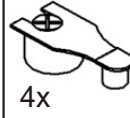

Čelo 2000x618x18

Vzpěra 2000x150x18

Sohl 2000x70x18

Bok 940x620x18

Bok 940x620x18

Vzpěra 900x182x18

Excentr  
8x

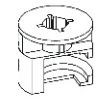

Šroub  
excentru  
8x

8x



Šroub  
excentru  
4x



3.

Lepidlo

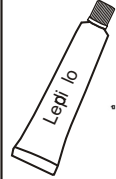

Čelo 2000x618x18

900x182x18

Sohl 2000x70x18

2x

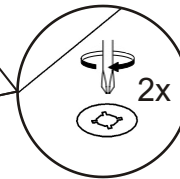

Pokud pohovku zalepíme lepidlem, už nebude možné ji rozebrat bez poškození.  
Postel je možné složit i bez lepidla.

4.

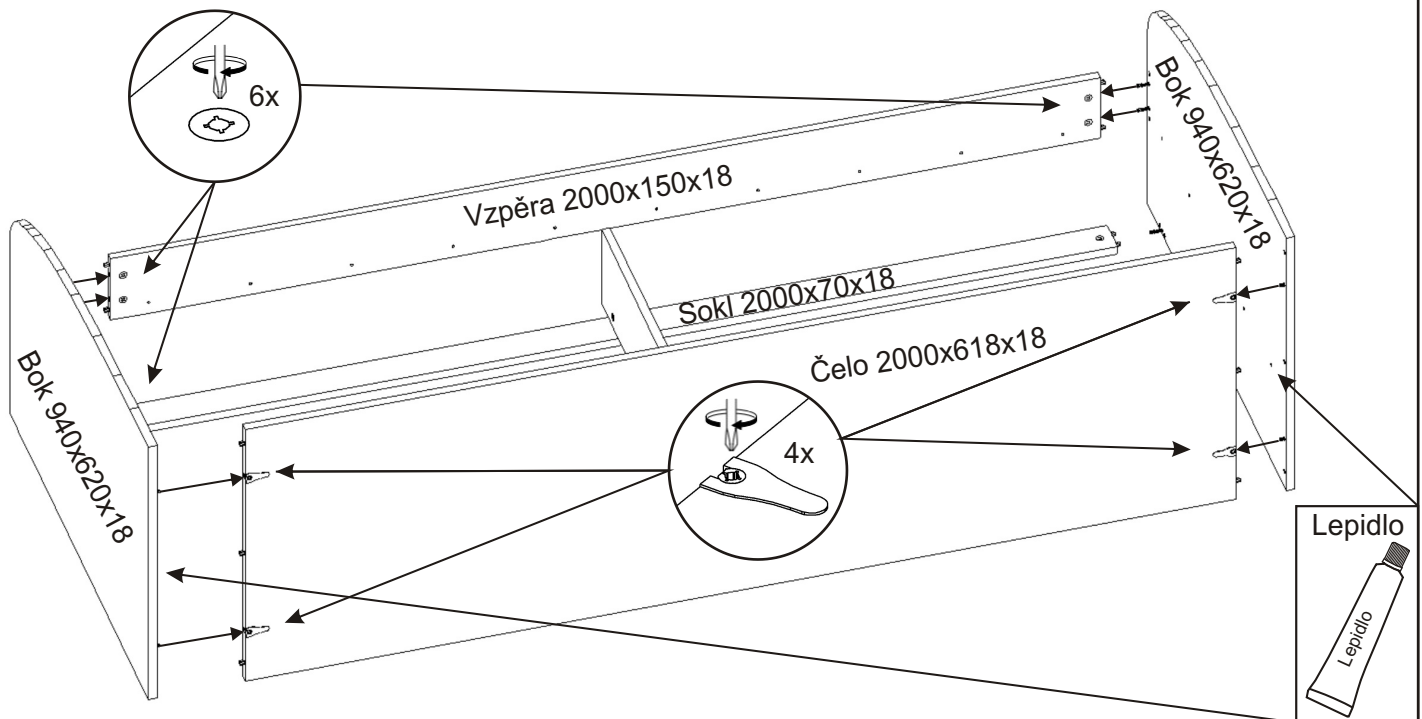

5.

Nejdříve připevníme rám k posteli a až následně natlučeme držáky lamel s lamelami.

Pevný rám s krytkami  
1998x898x50  
1x

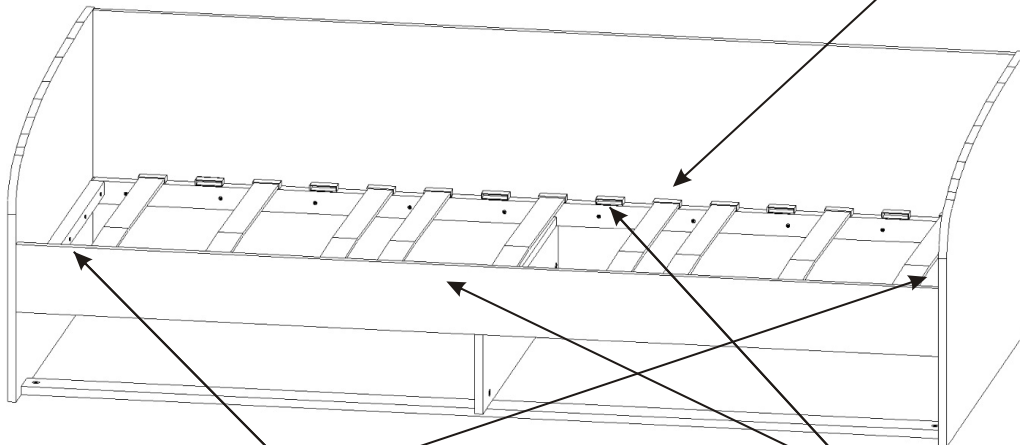
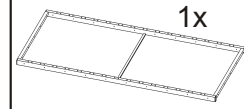

Držák lamel

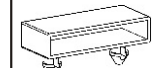

30x

Lamely  
885mm



15x

Vrut 4x45



30x

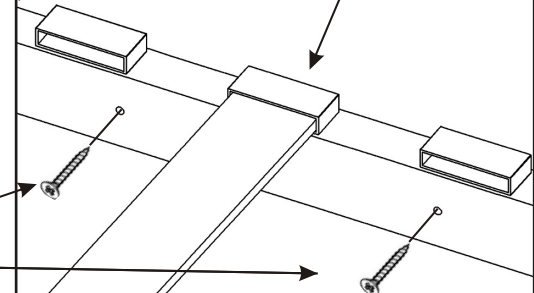
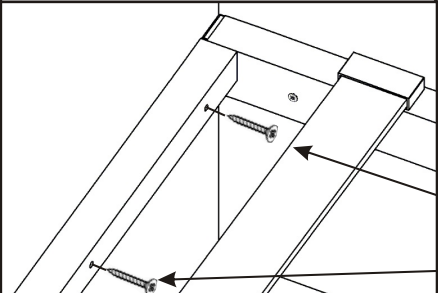

Do válendy vložíme matraci 2000x900x150. Následně navlékneme na matraci prostěradlo. Rovněž vsuneme úložné prostory.