

# Věšákové skříňky 740,840mm k výklopným postelím

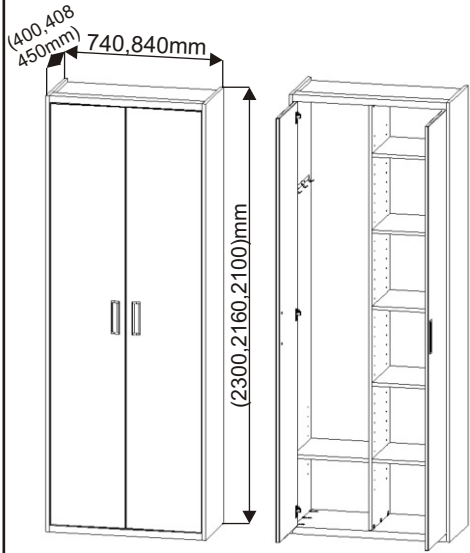

<b>Zapuštěná úchytka + šroubky 16mm</b>  4x <b>2x</b>	<b>Hřebík</b>  80x <b>80x</b>	<b>Spojovací excentr malý + šroubky</b>  12x 12x <b>12x 12x</b>	<b>Spojovací excentr Velký + šroubky</b>  12x 12x <b>12x 12x</b>	<b>Policové podpěrky</b>  24x <b>24x</b>
<b>Věšák trojitý</b>  280mm <b>1x</b>	<b>Vložený pant s tlumením</b>  6x <b>6x</b>	<b>Vrut 3,5x16</b>  4x <b>4x</b>	<b>Vrut 4x16</b>  24x <b>24x</b>	<b>Vrut 4x30</b>  8x <b>8x</b>

1.

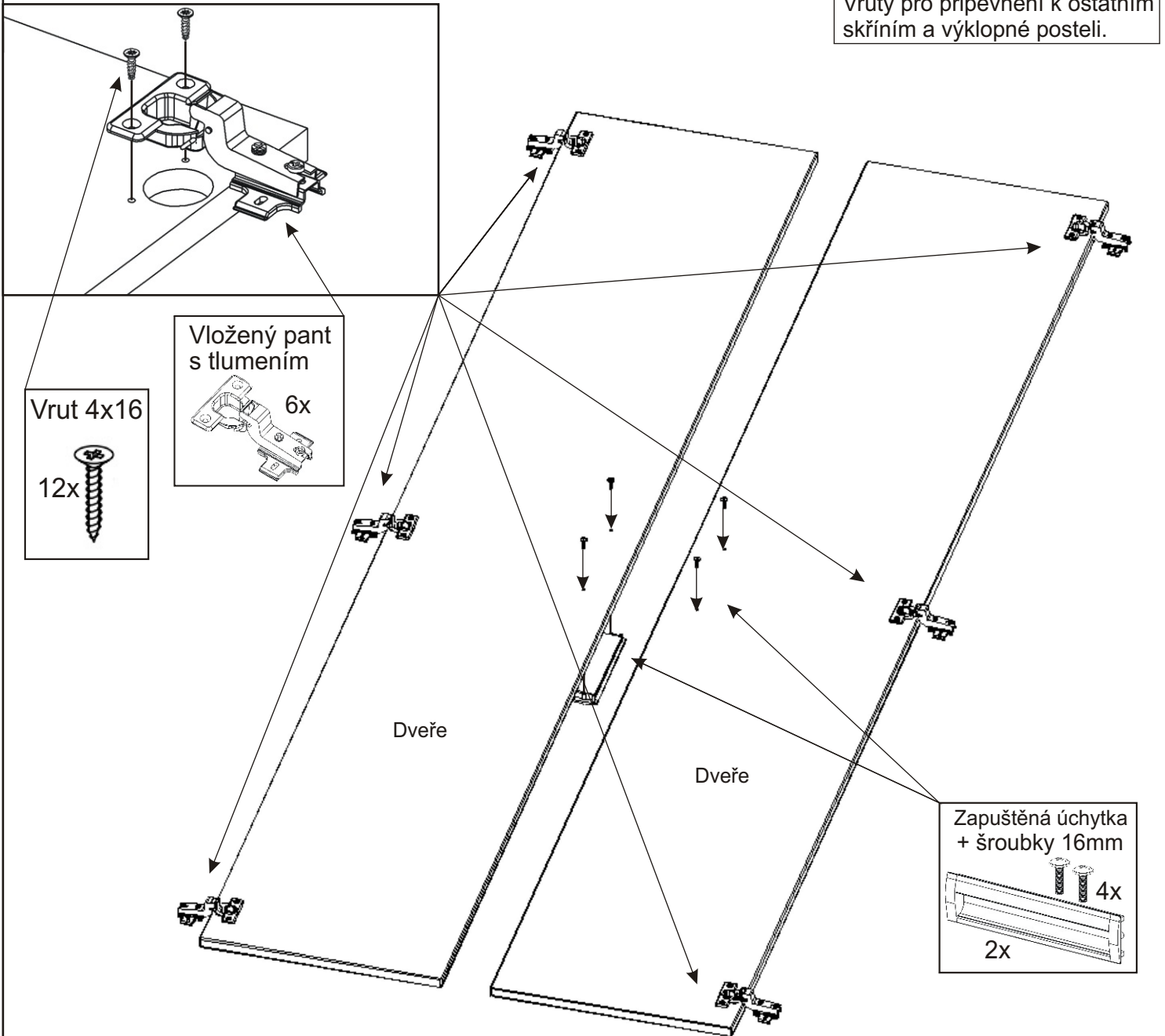

2.

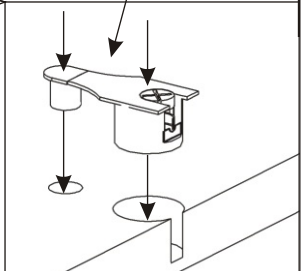
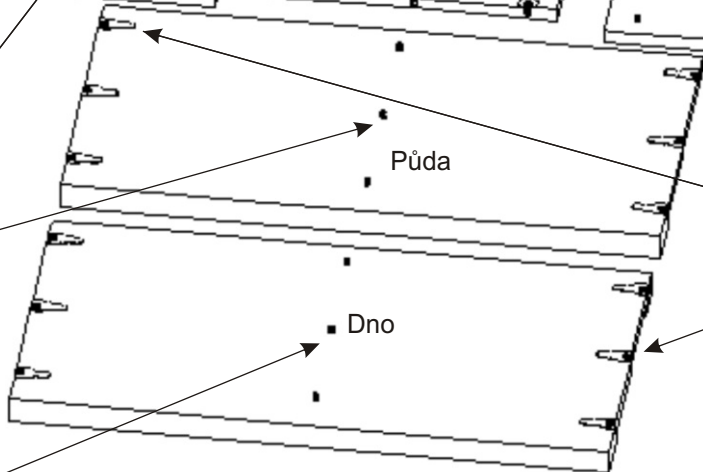
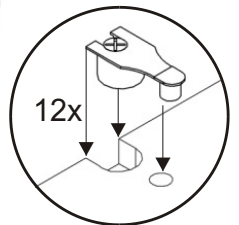
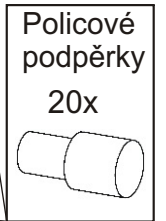
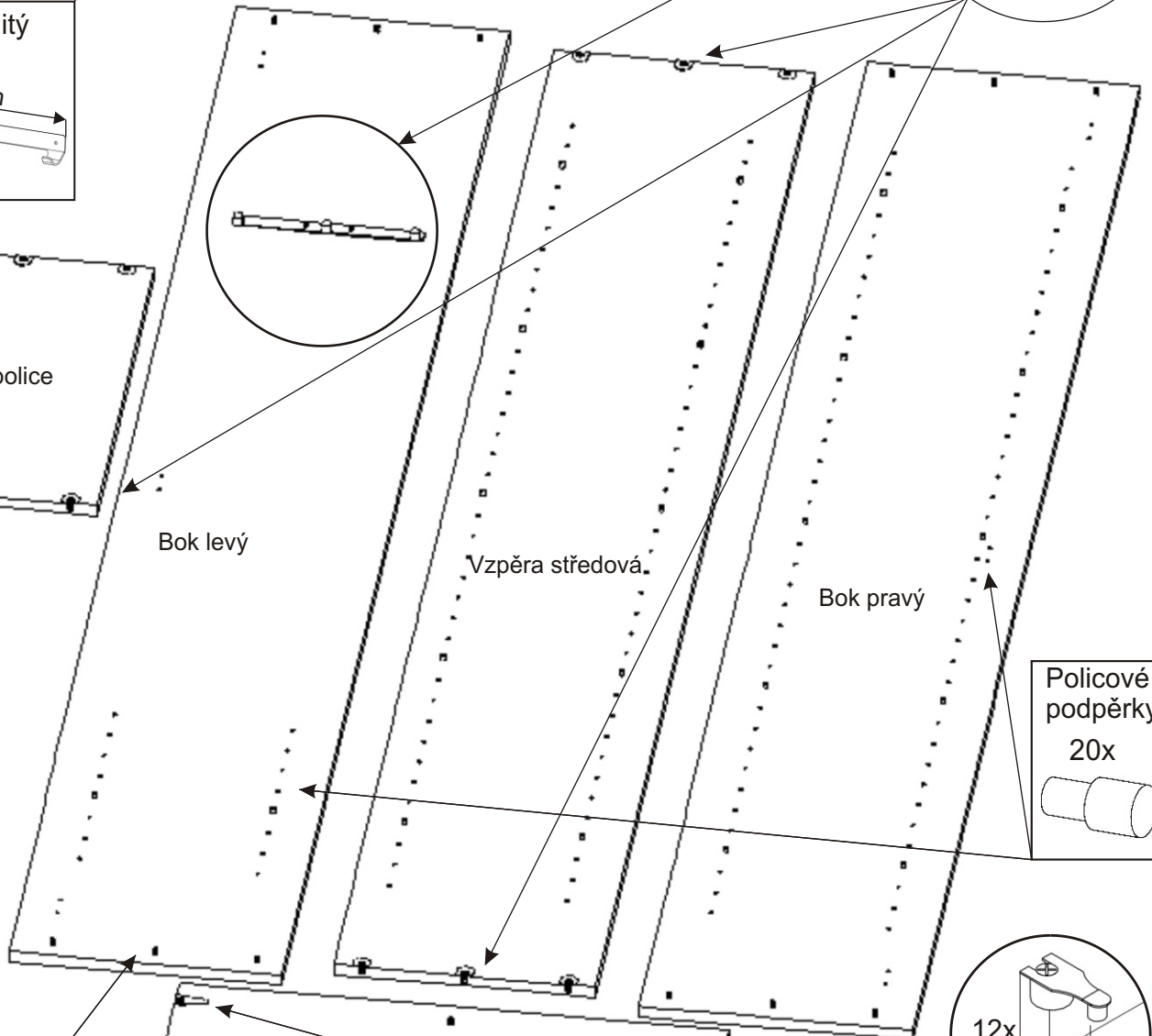
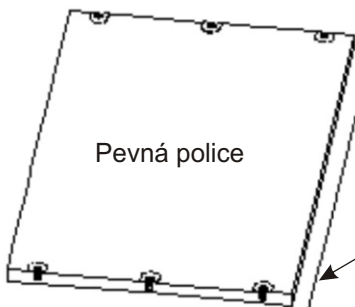
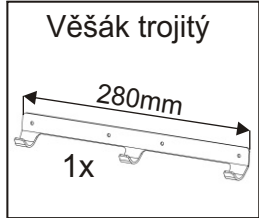
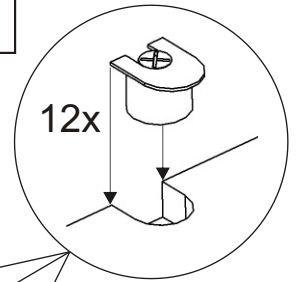
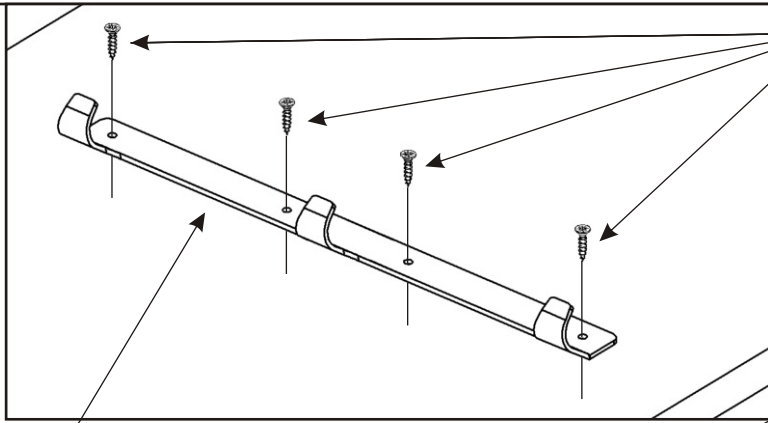

Excentry je důležité naklepat souběžně na jednu i druhou stranu aby nedošlo k vylomení.

3.

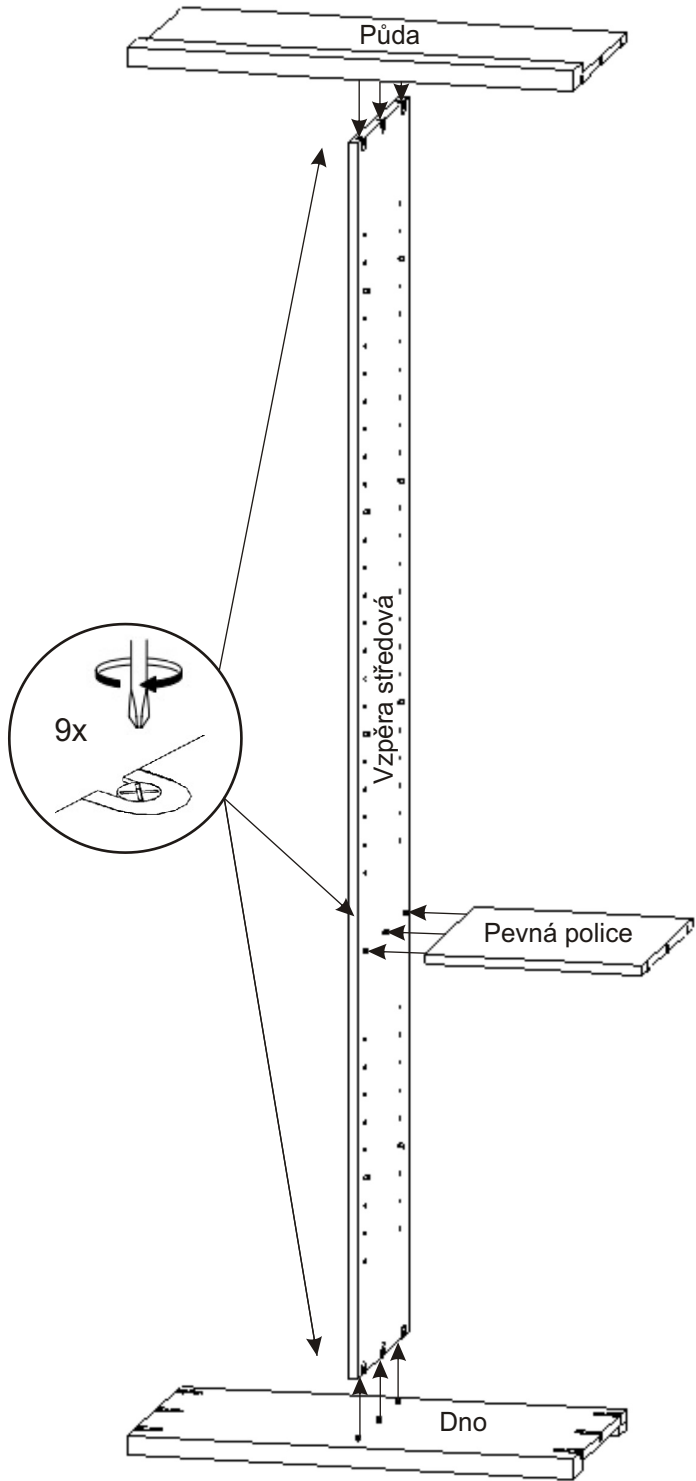

4.

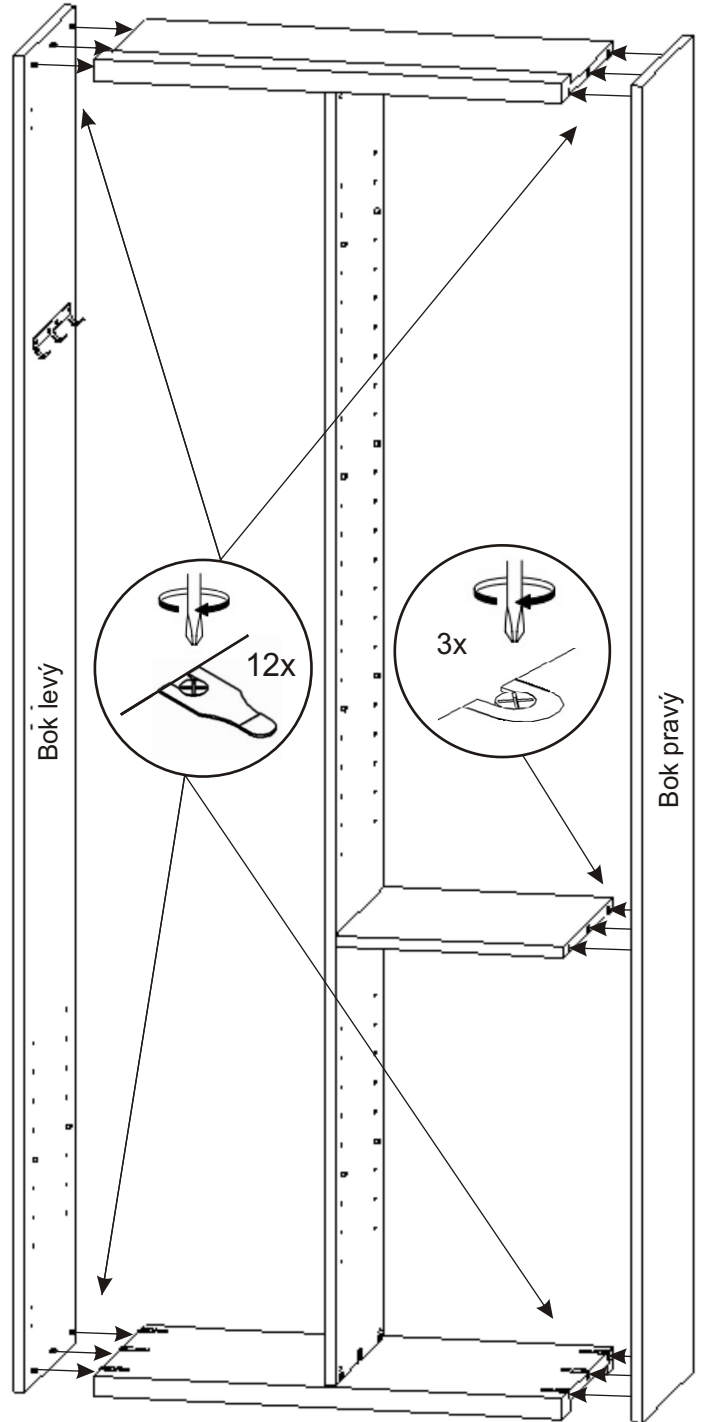

5.

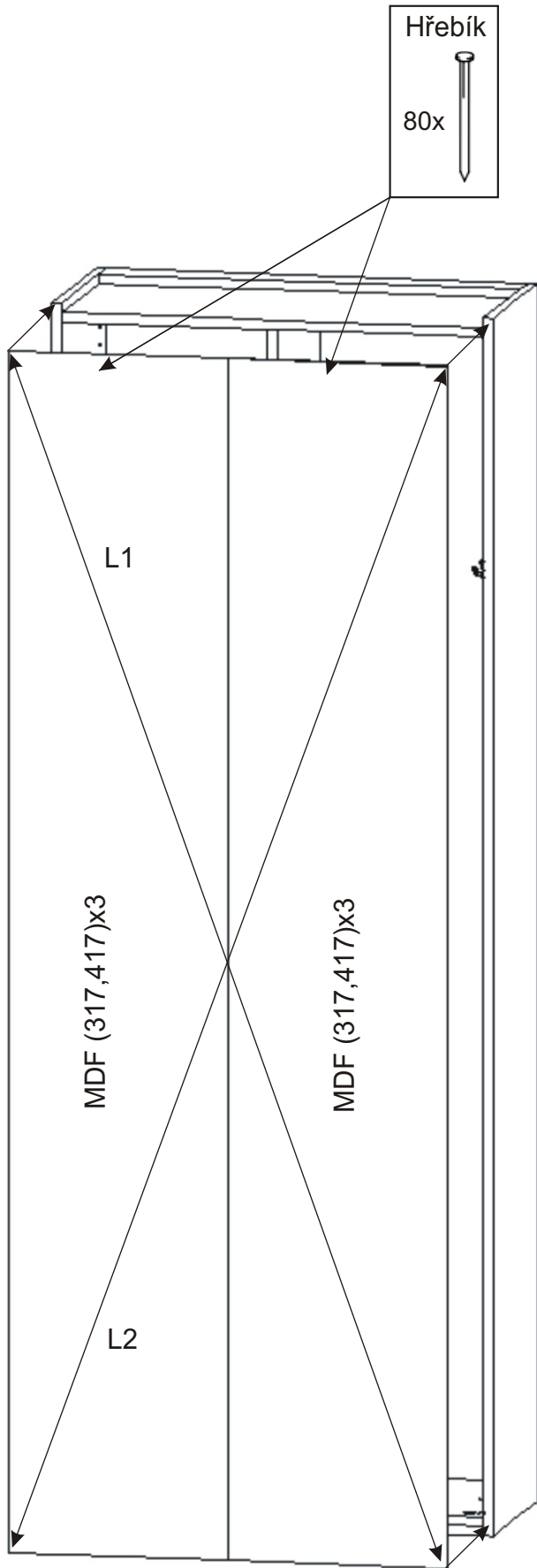

6.

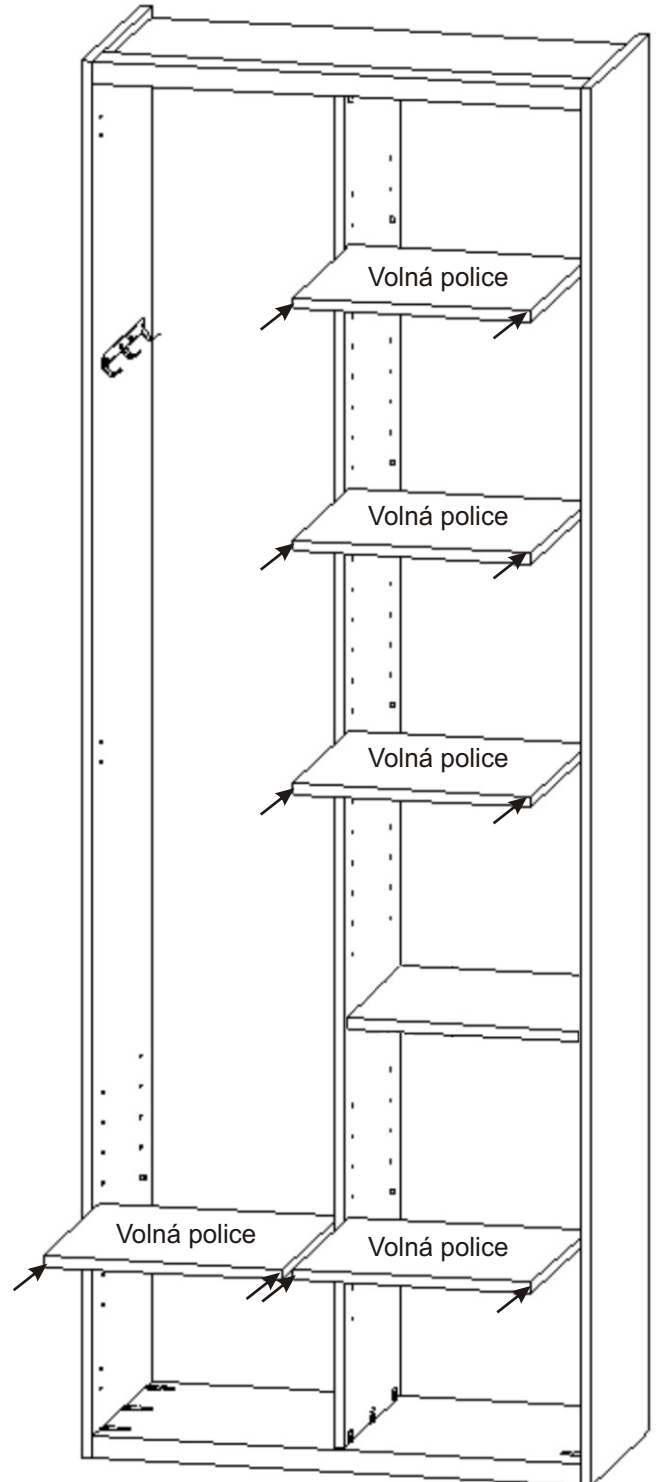

7.

Vrut 4x16  
12x



Dveře

