

K 32 koupelňová skříňka vysoká s košem

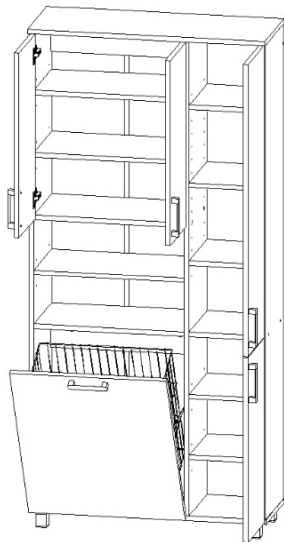
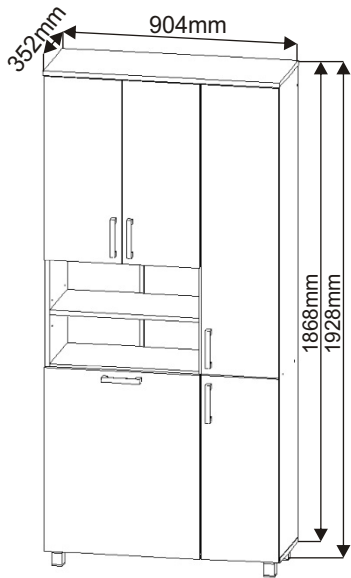

| | | | | |
|-------------------------|-----------------------------|-------------------------------------|---------------------------------|-------------------|
| Naložený pant 8x | Polonaložený pant 2x | Úchytka plastová 5x 128mm | Šroub 4x30 k úchytce 10x | Krytka 16x |
|-------------------------|-----------------------------|-------------------------------------|---------------------------------|-------------------|

| | | | | | |
|---------------------------|-------------------|----------------------|------------------------|-----------------------|-----------------------------|
| Konfirmát 50mm 14x | Hřebík 80x | Vrut 4x16 40x | Vrut 3,5x16 14x | Kolík 35mm 53x | Lepidlo 40ml 1x 10ml 1x |
|---------------------------|-------------------|----------------------|------------------------|-----------------------|-----------------------------|

| | | | | |
|------------------------------|----------------------|----------------------|-----------------------------------|--------------------------|
| Policové podpěrky 32x | Držák koše 6x | Závěs koše 2x | Drátěný koš 510x290x510 1x | H lišta 1682mm 1x |
|------------------------------|----------------------|----------------------|-----------------------------------|--------------------------|

Varianta plastové nohy:

| | |
|------------------------------|------------------------|
| Plastová noha 60mm 4x | Vrut 3,5x16 16x |
|------------------------------|------------------------|

Varianta zavěšení na zeď:

| | | | |
|-------------------------|---------------------|---------------------|--|
| Hmoždinka ø12 6x | Vrut 6x70 6x | Vrut 4x20 4x | Závěsné kování Bystrica 52x50x39mm 2x |
|-------------------------|---------------------|---------------------|--|

1.

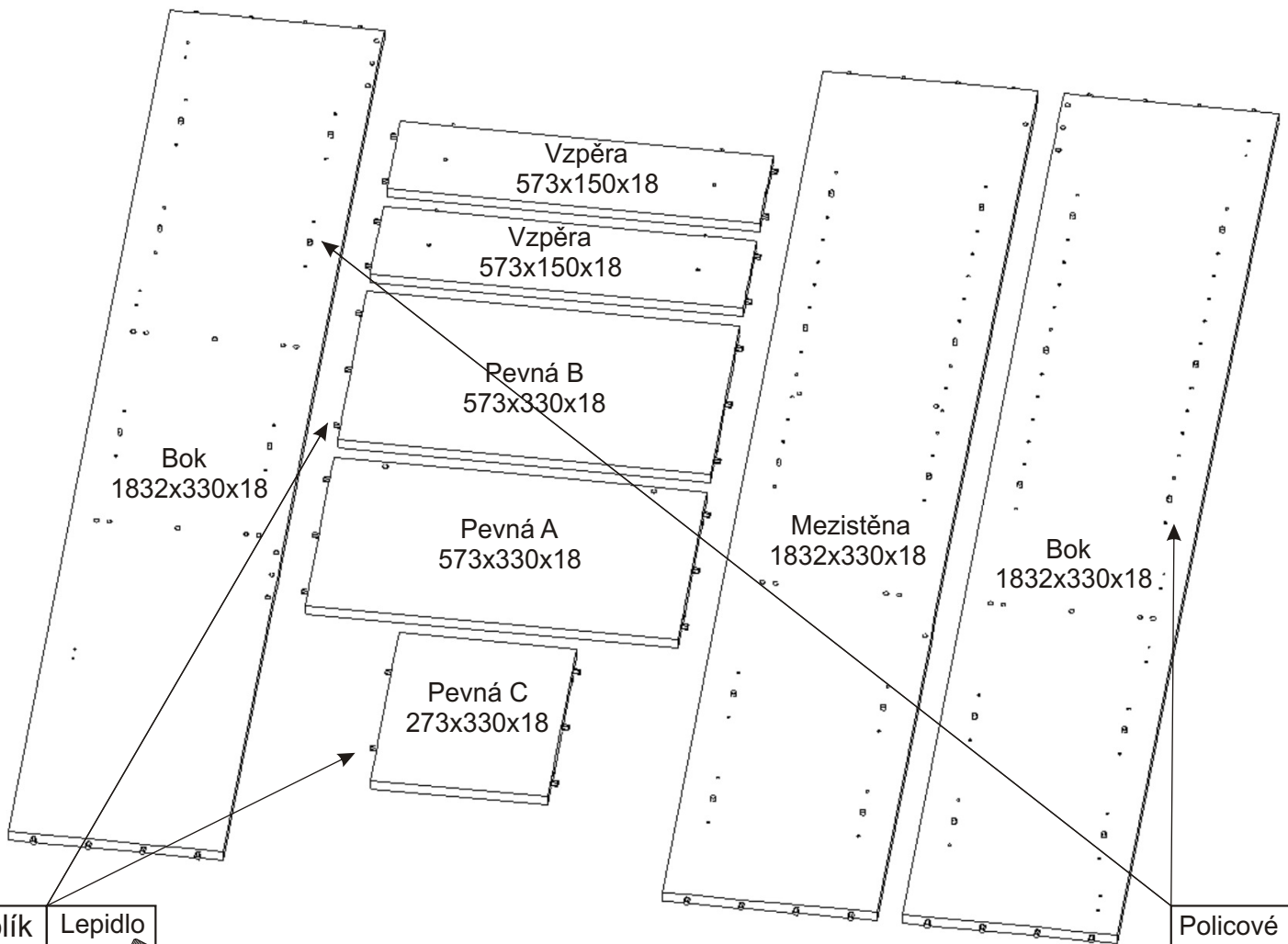

| | |
|-----------------------|-------------|
| Kolík 35mm 53x | Lepidlo |
|-----------------------|-------------|

| |
|------------------------------|
| Policové podpěrky 32x |
|------------------------------|

2.

Polonaložený pant
2x

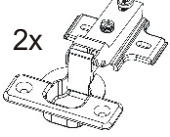

Vrut 4x16
4x

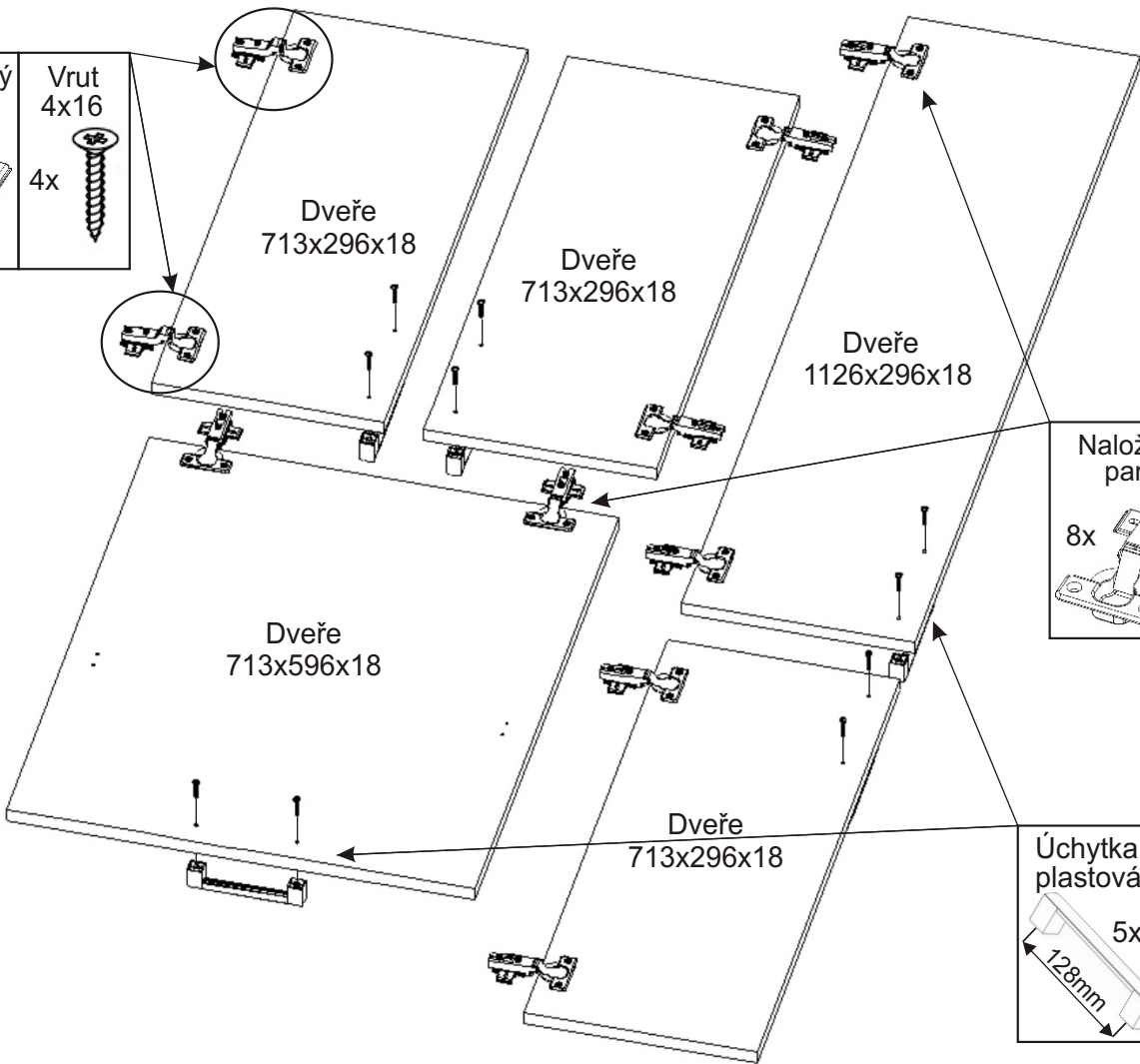

Naložený pant
8x

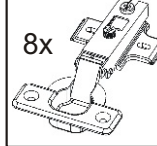

Vrut 4x16
16x

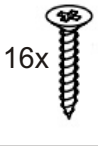

Úchytka
plastová
5x

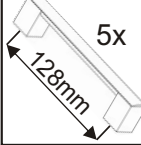

Šroub 4x30
k úchytce
10x

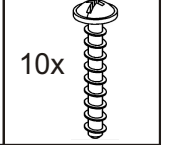

3.

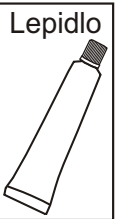
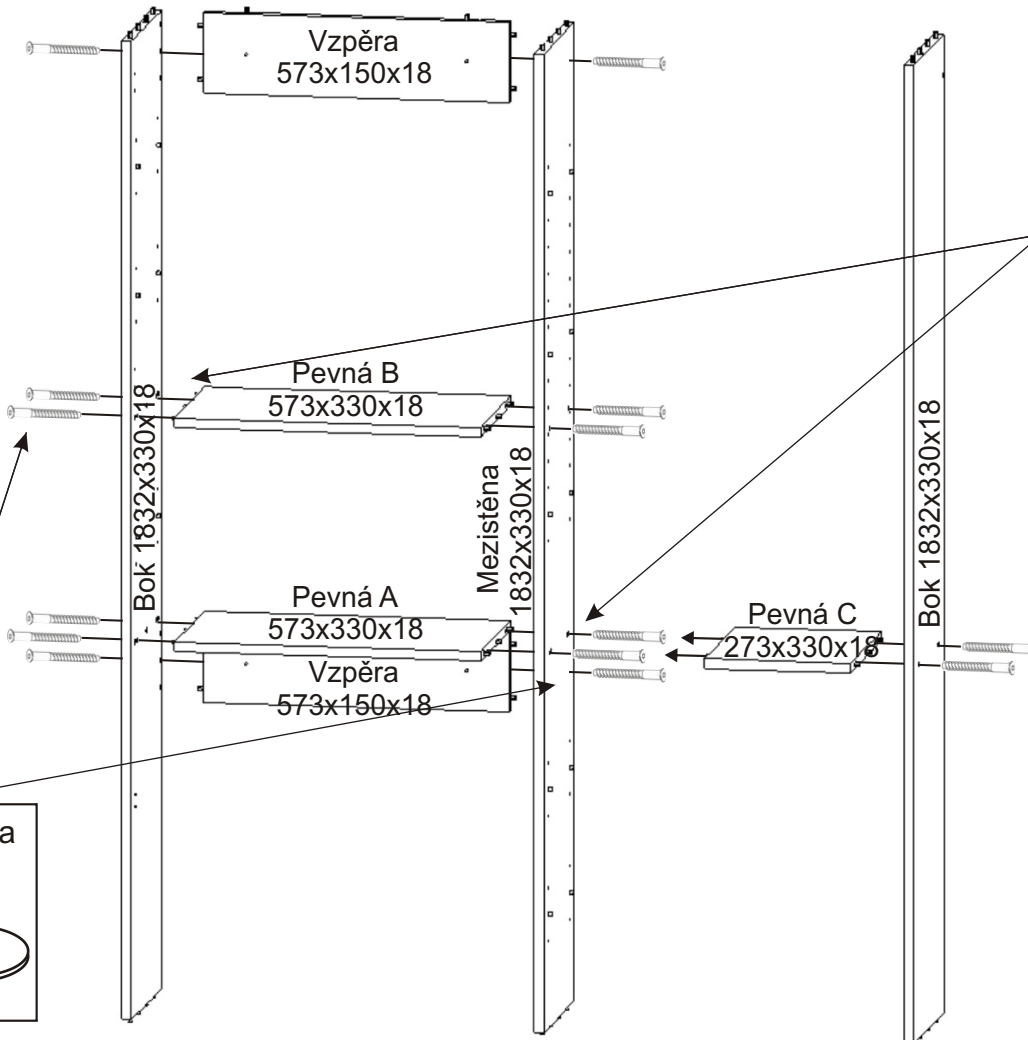

Konfirmát
50mm
14x

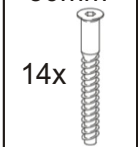

Krytka
12x

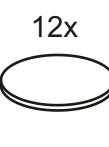

4.

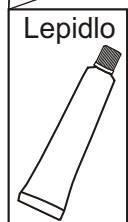
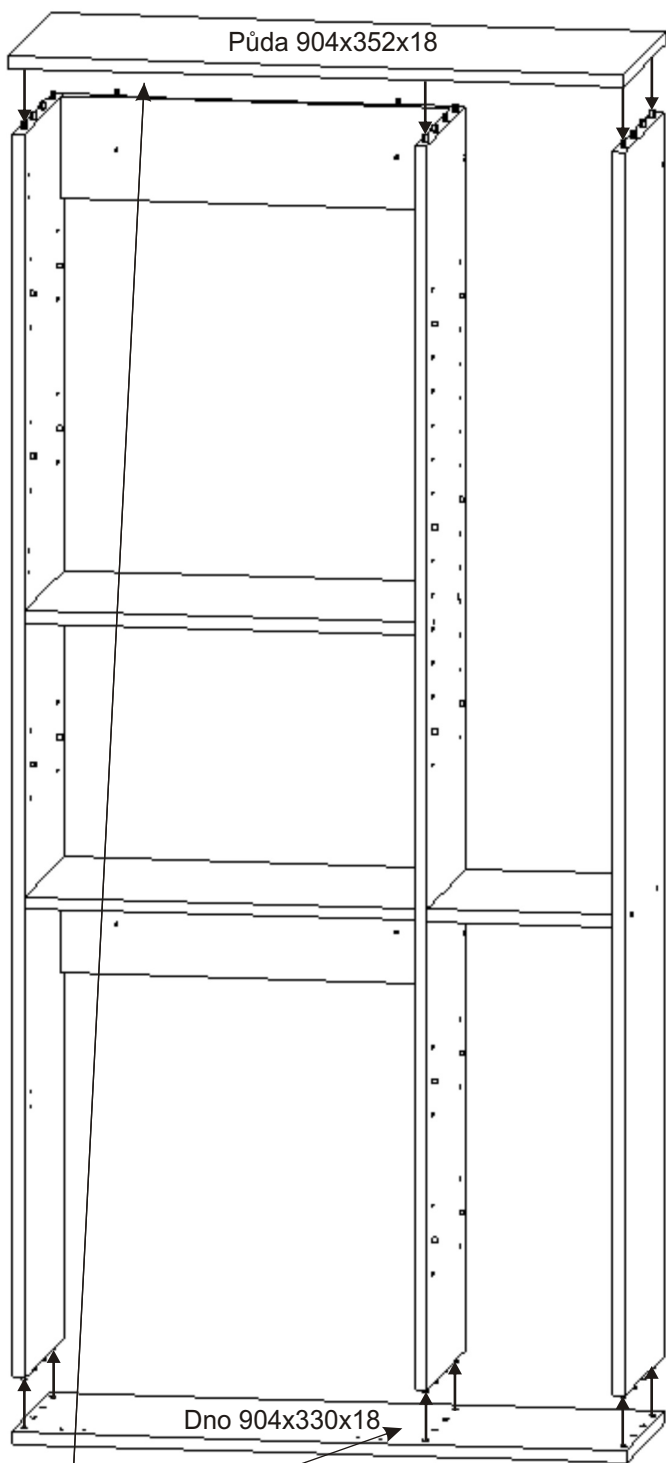

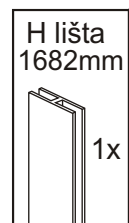
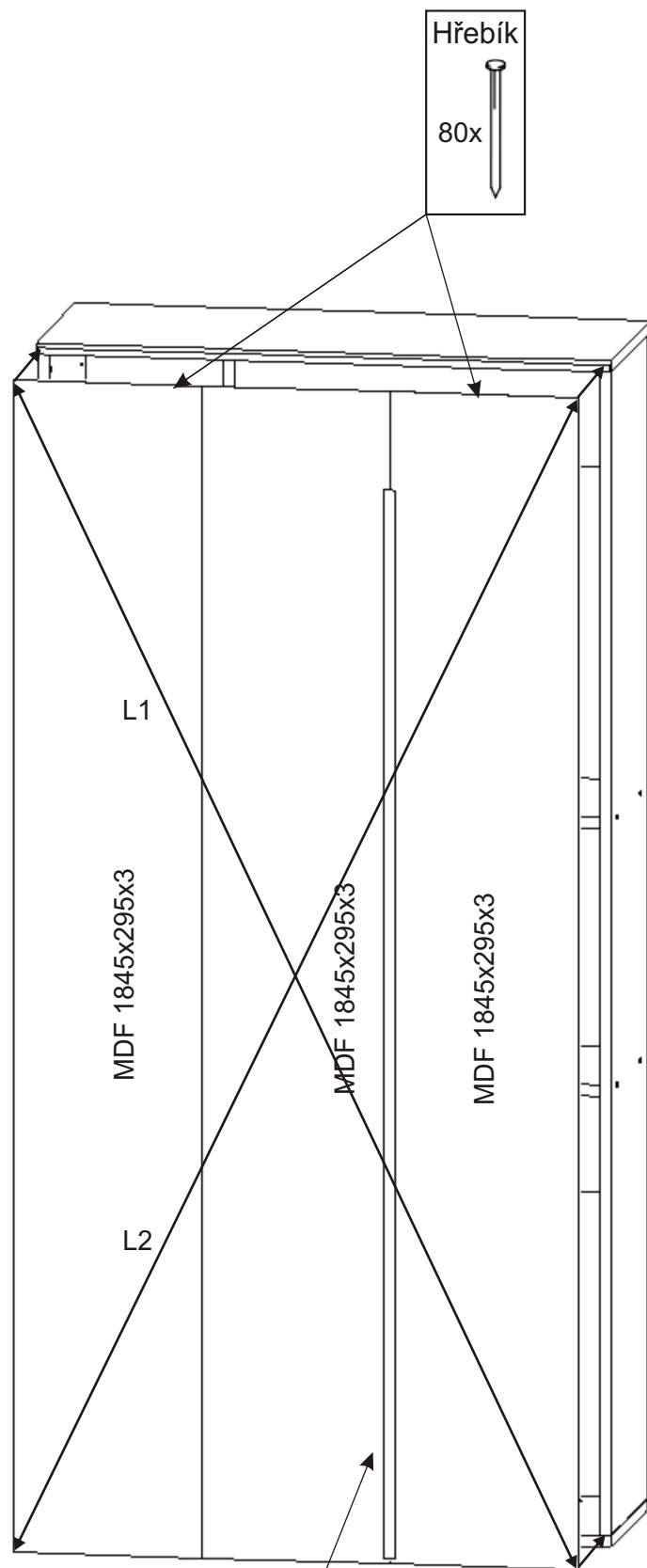

5.

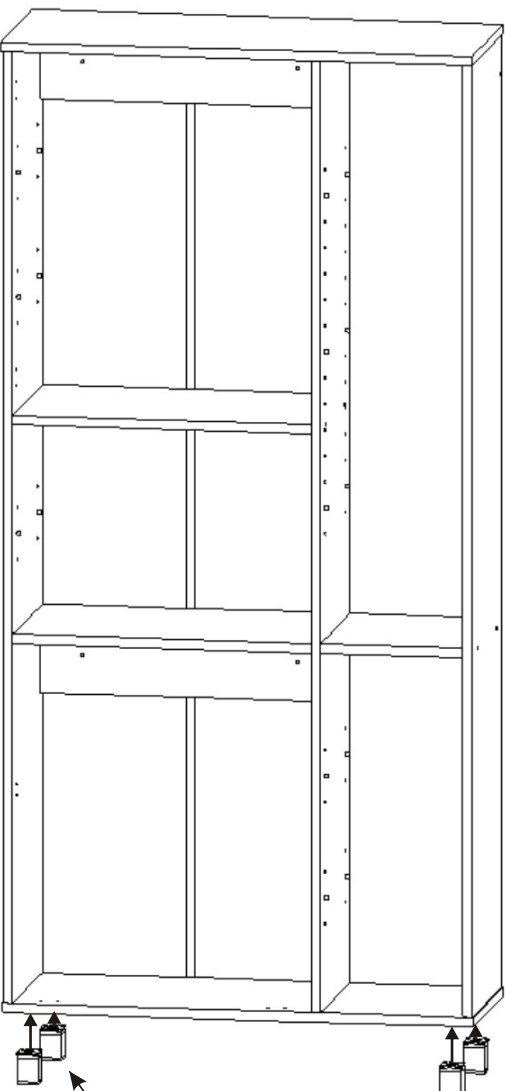

L1 = L2

6.A. Varianta plastové nohy





| | |
|---|---|
| <p>Plastová noha 60mm</p> <p>4x</p>  | <p>Vrut 3,5x16</p> <p>16x</p>  |
|---|---|

6.B. Varianta zavěšení na zeď:

U této varianty skříň připevníme ke zdi pomocí hmoždinek.

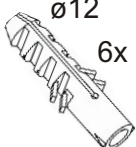
Hmoždinka
ø12
6x



| | |
|---|--|
| <p>Vrut 6x70</p> <p>4x</p>  | <p>Krytka</p> <p>4x</p>  |
|---|--|

Do zad v MDF sololitu provrtáme otvor minimálně ø8mm.

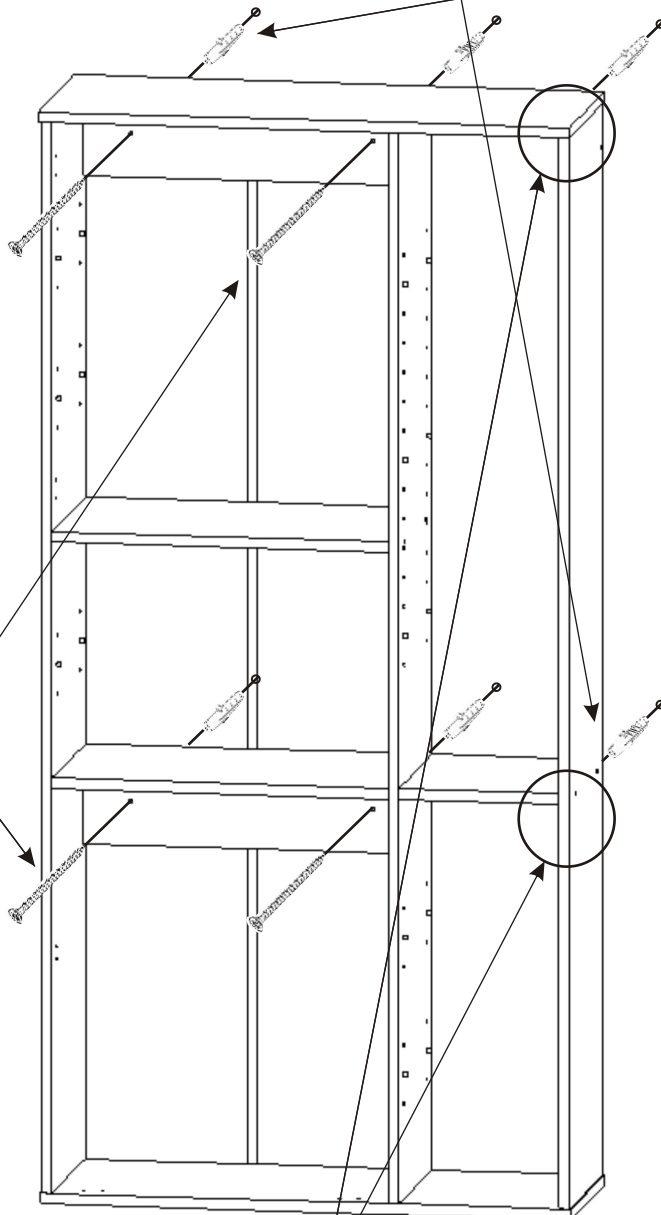

6.1.

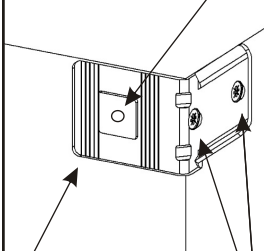

Závěsné kování Bystrica

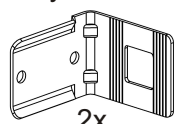

6.2.

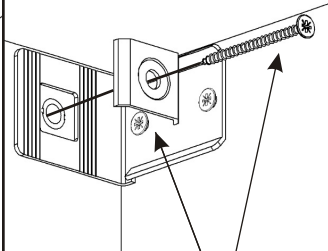

Vrut 4x20

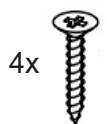

Vrut 6x70



Závěsné kování Bystrica-podložka

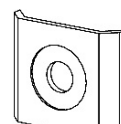

6.3.

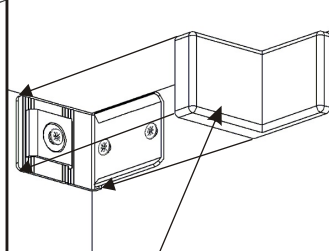

Závěsné kování Bystrica - krytka

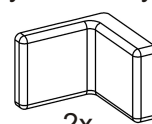

7.

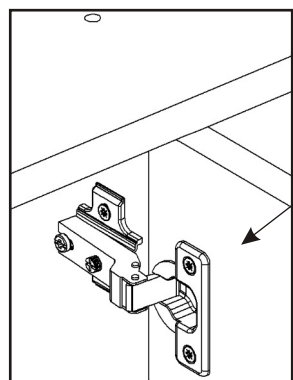

Dveře s polonaloženými panty.
Je důležité neprohodit typy pantů.

Vrut
4x16
20x

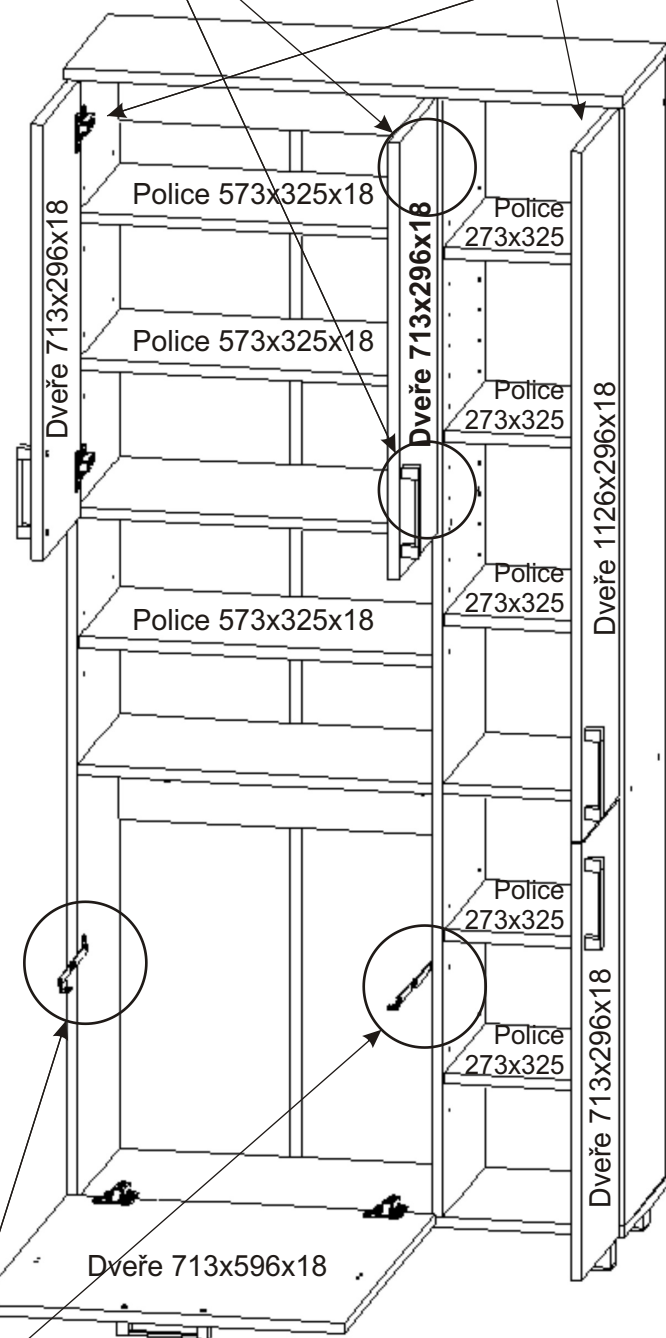
Vrut
3,5x16
4x



Závěs koše
2x

8.

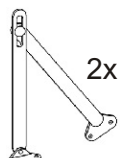
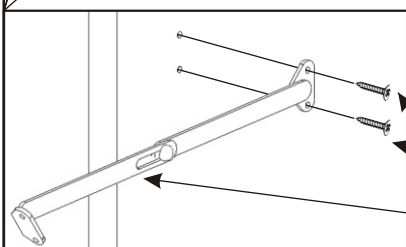

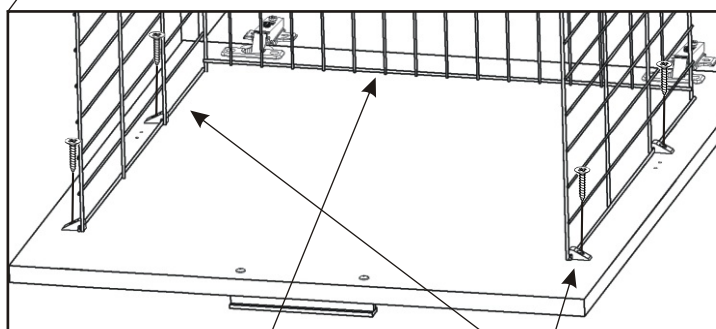
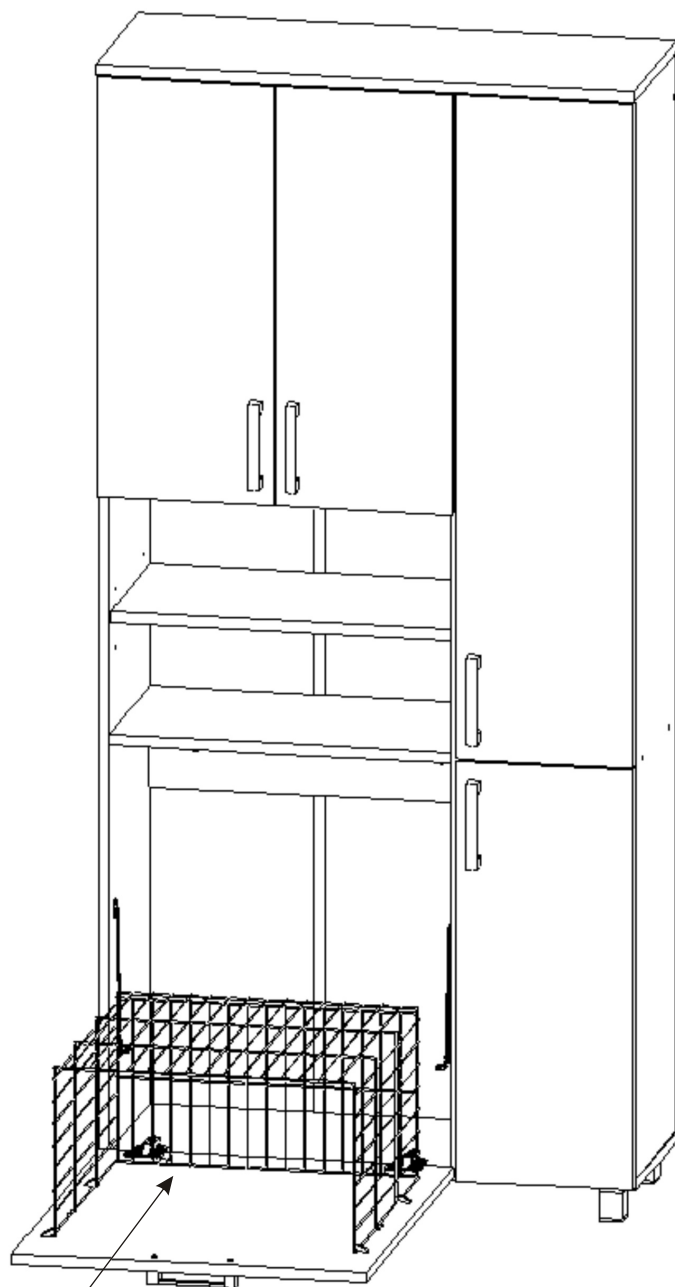

Drátěný koš
510x290x510
1x

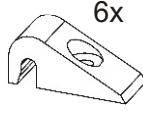

Držák koše
6x

Vrut
3,5x16
6x

9.

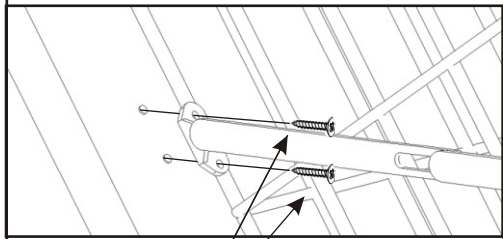

Vrut
3,5x16
4x

