

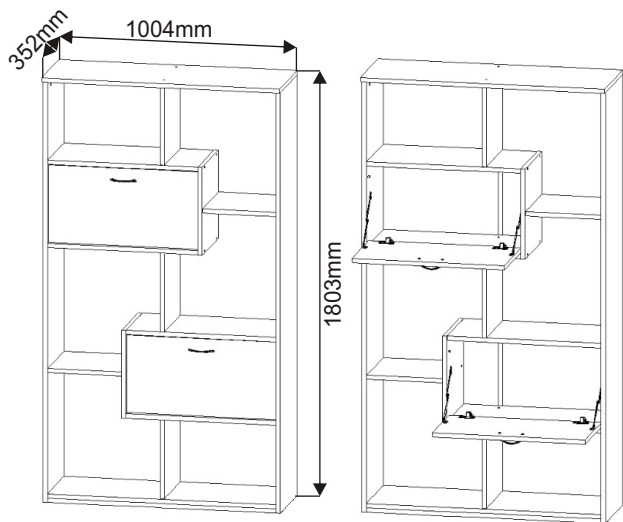









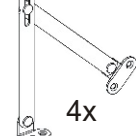
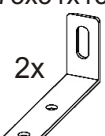

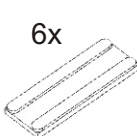



ALFA 183

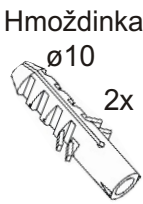

| | | | | | | |
|--|--|---|--|--|---|--|
| Vložený pant s tlumením  4x | Závěs dveří  4x | Úhelník 73x31x15  2x | Excentr 20x  20x | Šroub excentru 20x  20x | Kluzáky 6x  6x | |
| Úchytka 96mm  2x  4x22mm | Kolík 35mm  30x | Lepidlo 40ml  1x | Konfirmát 50mm  24x | Hmoždinka ø10  2x | Hřebík  82x | Krytka velká 38x  38x |
| Policové podpěrky 4x  4x | Vrut 3,5x16  16x | Vrut 4x16  8x | Vrut 4x20  12x | Vrut 4x30  8x | Vrut 5x50  2x | H lišta 334mm  2x |

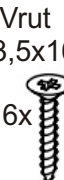
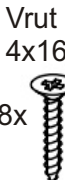
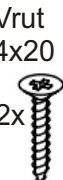
1.

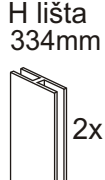
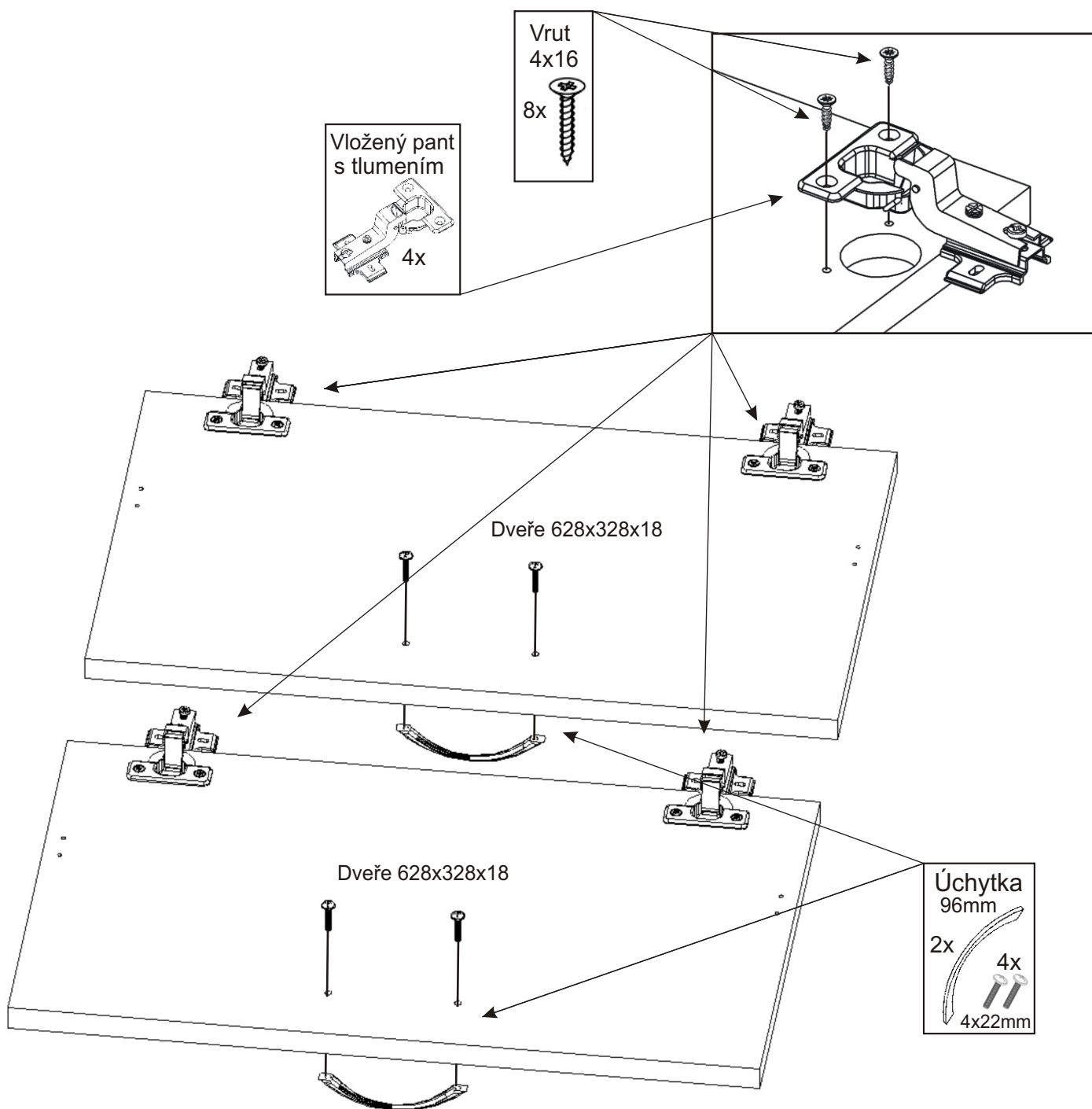

2.

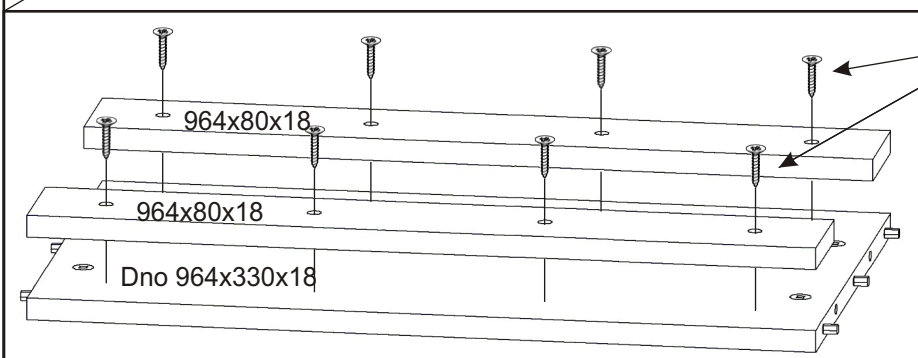
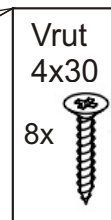
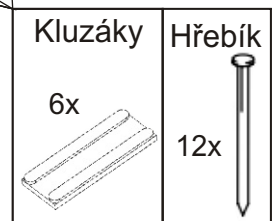
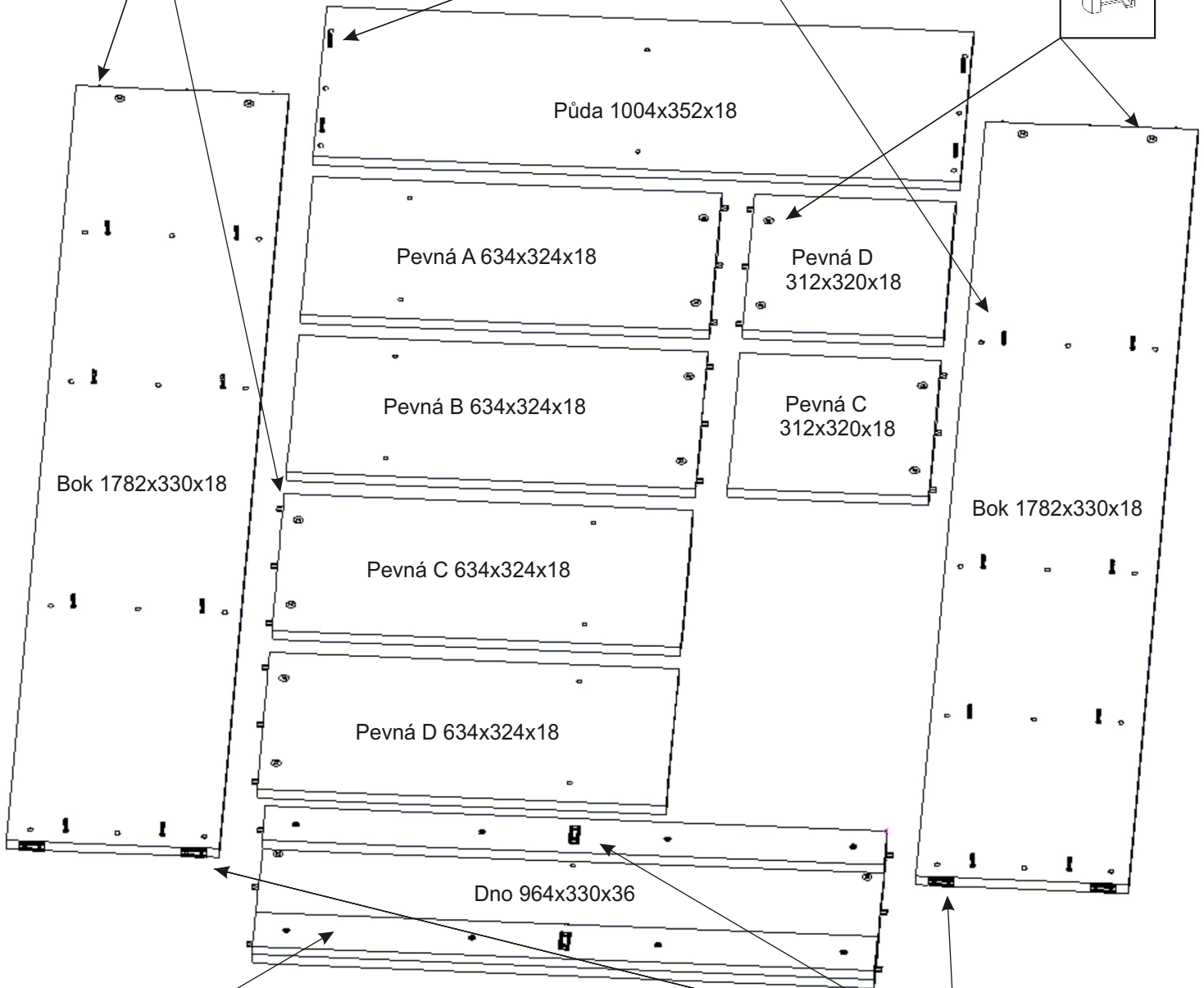
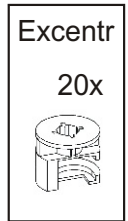
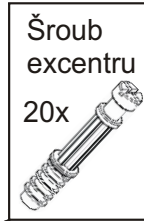
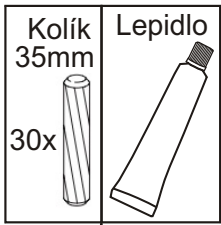

3.

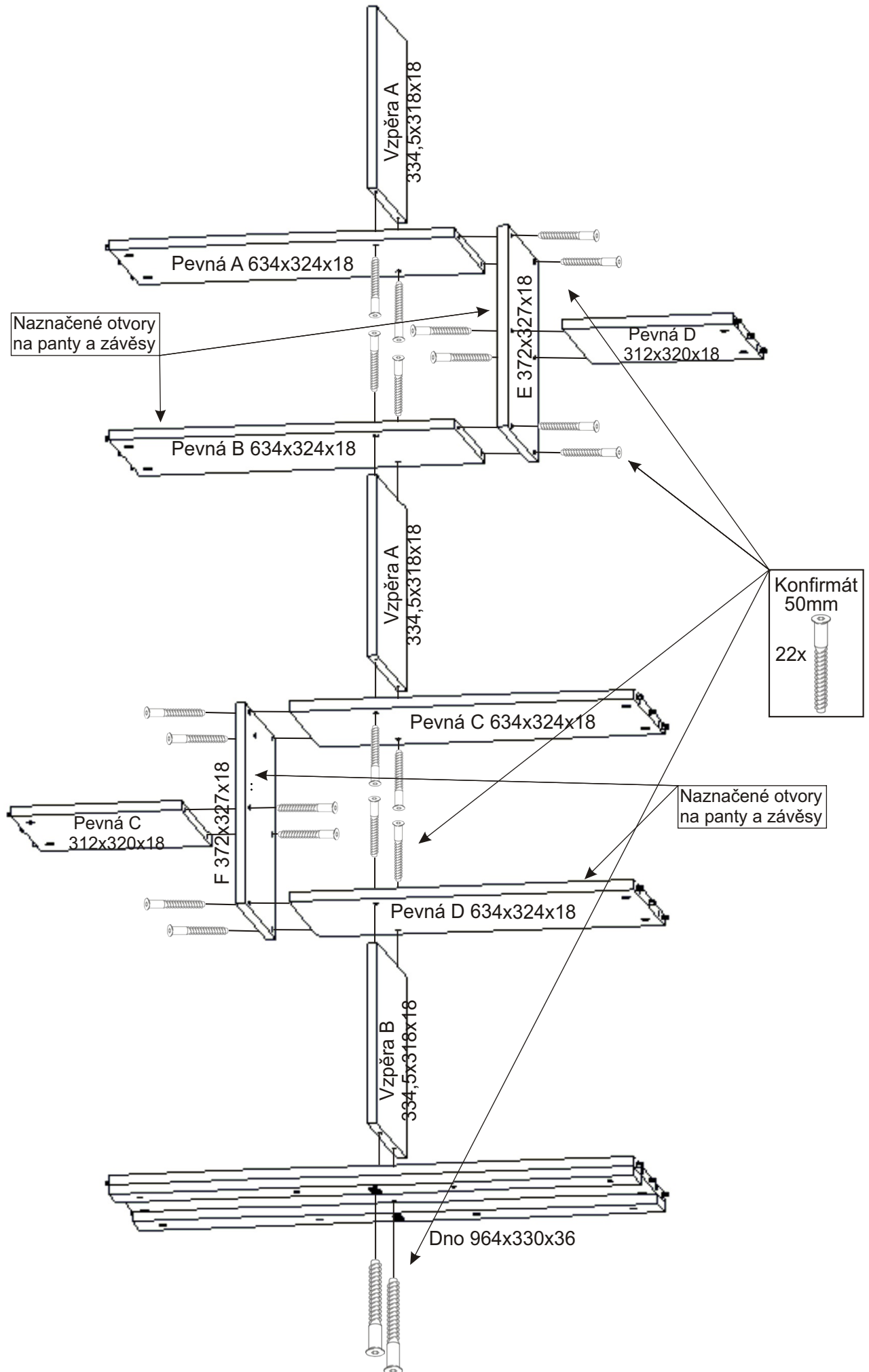

4.

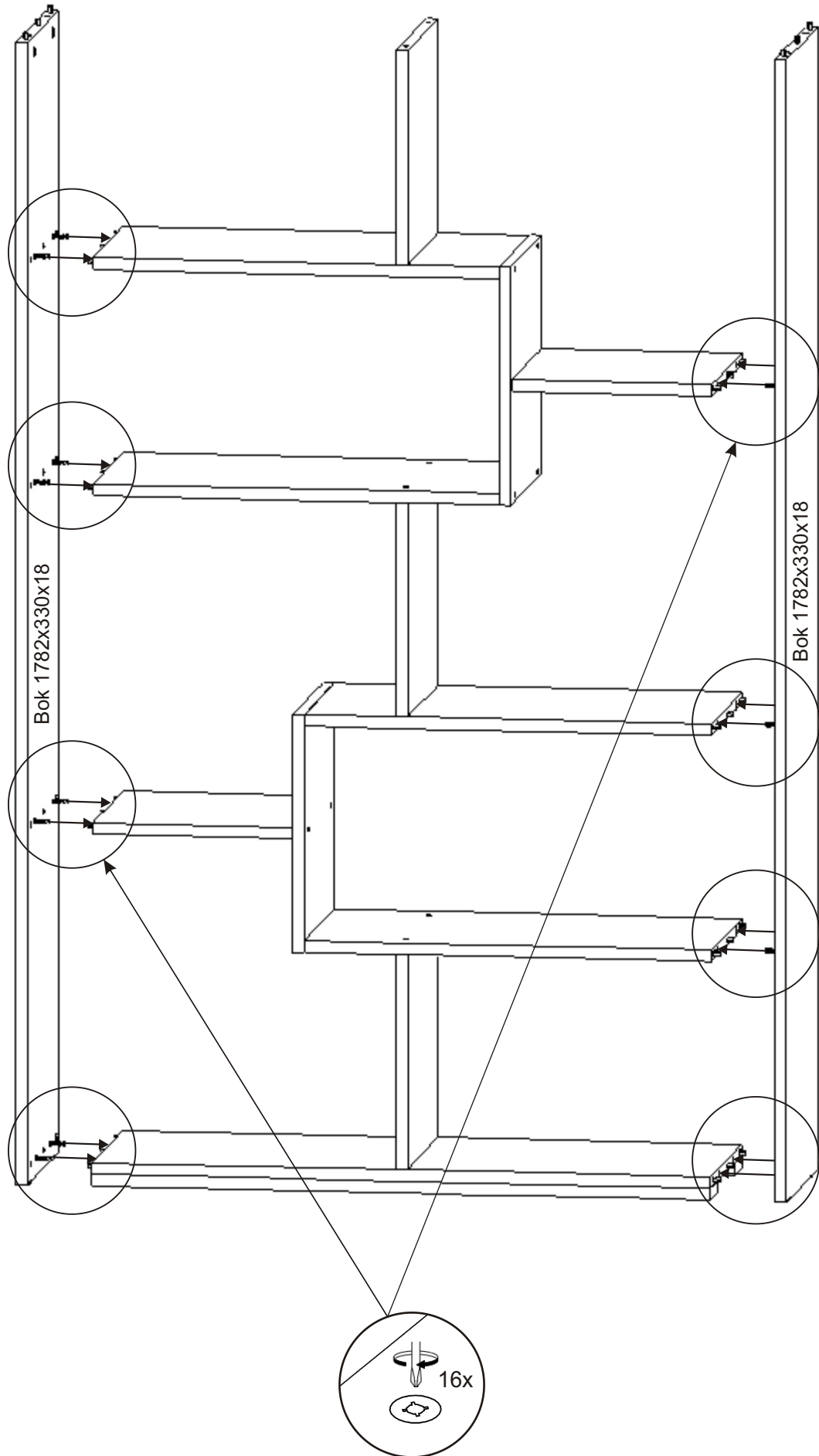

5.

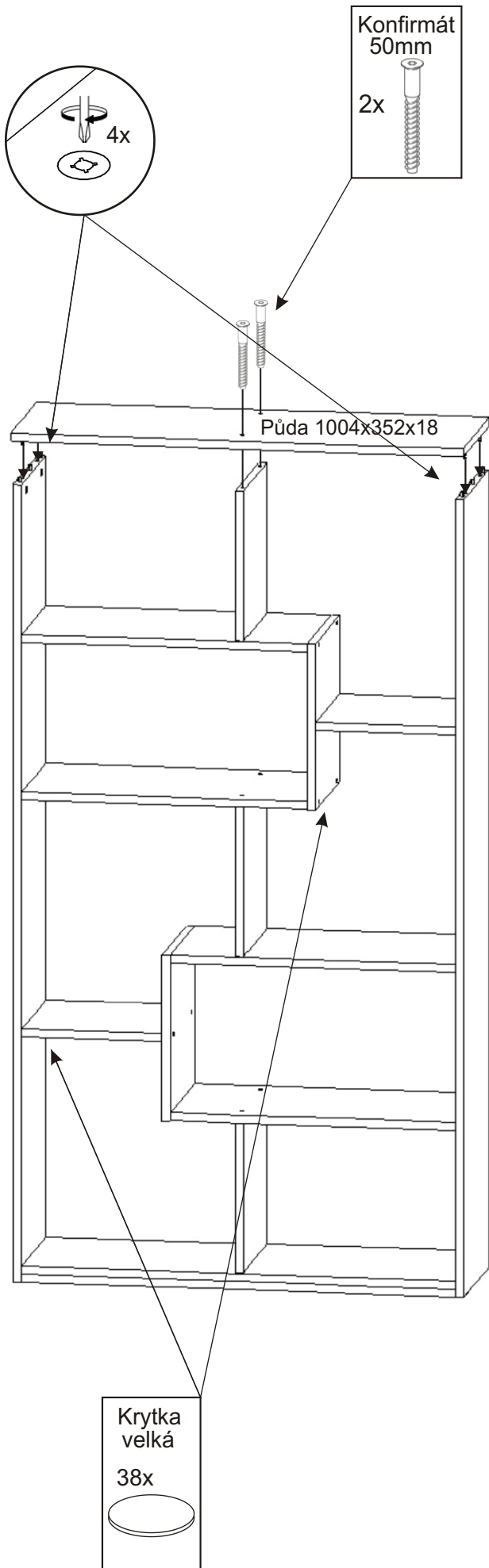

6.

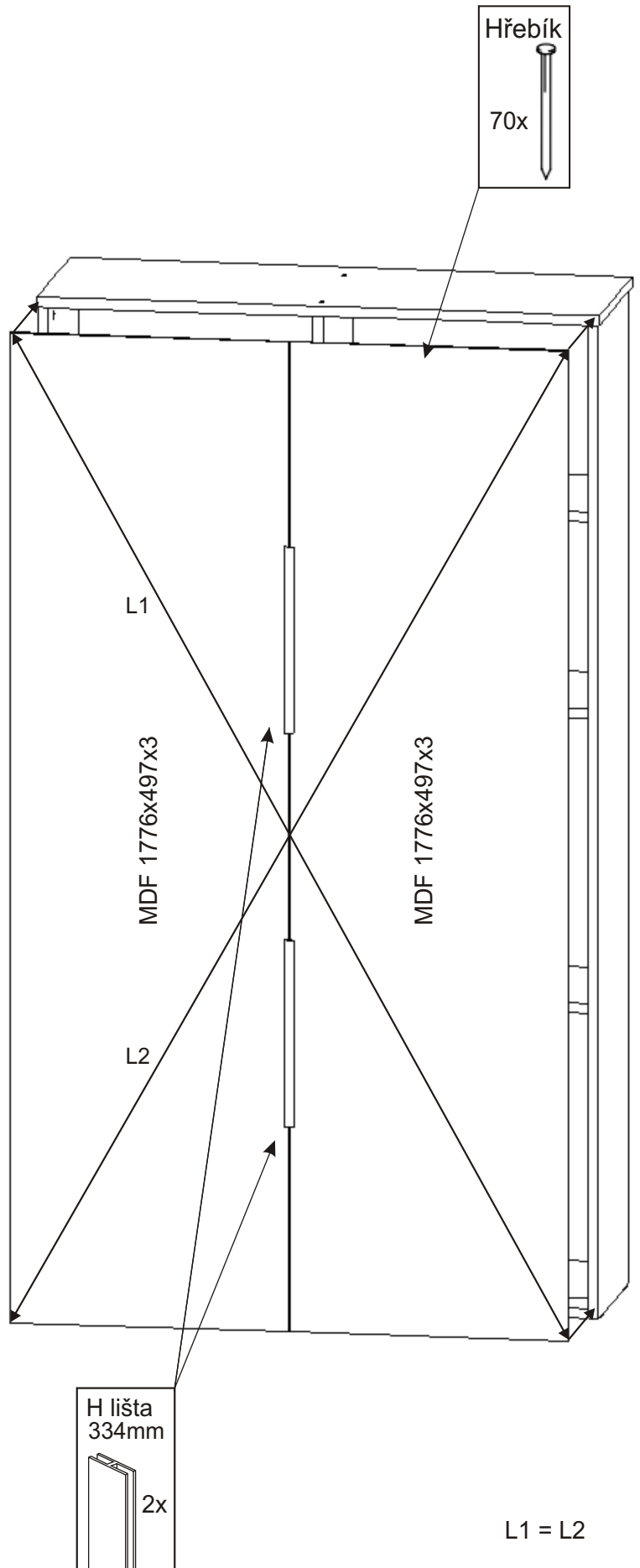

7.

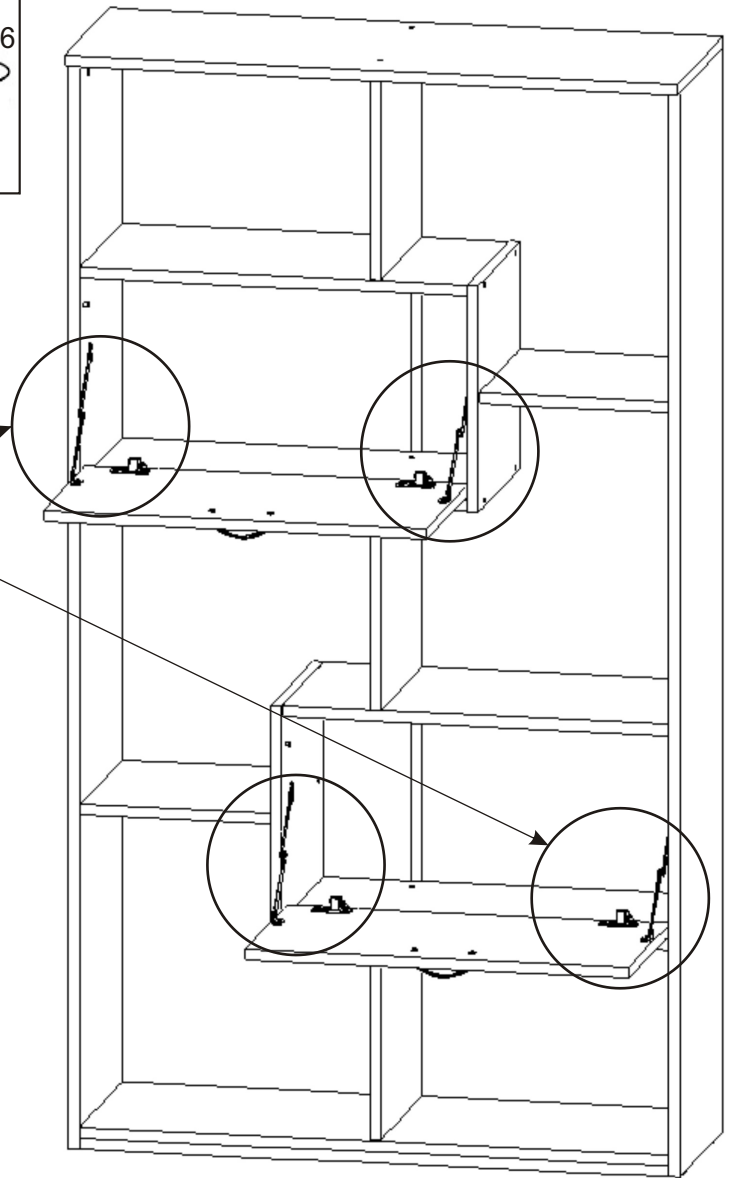
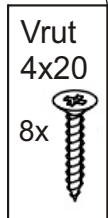
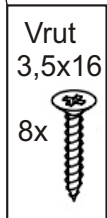
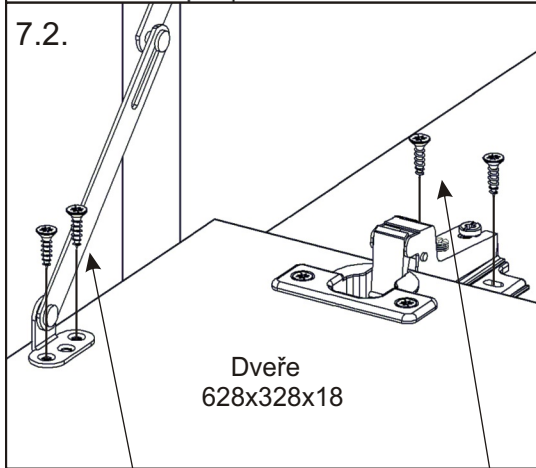
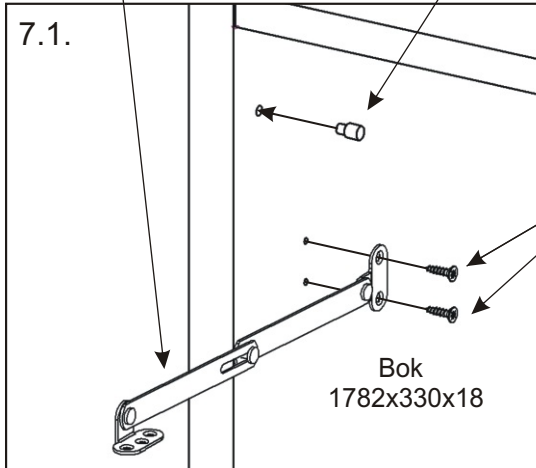
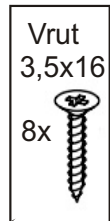
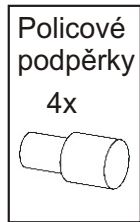

8.

Skříň doporučujeme kvůli nebezpečí převržení připevnit ke zdi pomocí úhelníků. Skříň přisuneme ke zdi na místo kde bude umístěna a naznačíme otvory pro hmoždinky. Navrtáme otvory pro hmoždinky a připevníme dodanými vruty. (Námi dodávané hmoždinky jsou vhodné pro stěny z plných materiálů.)

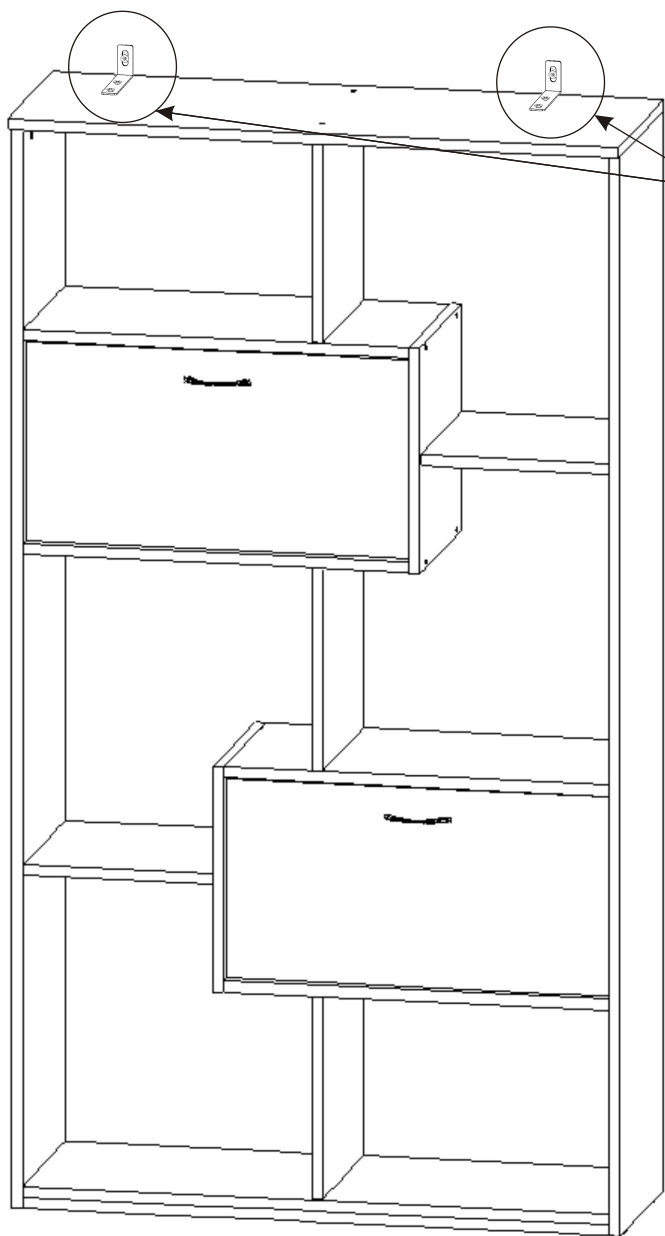

8.1.

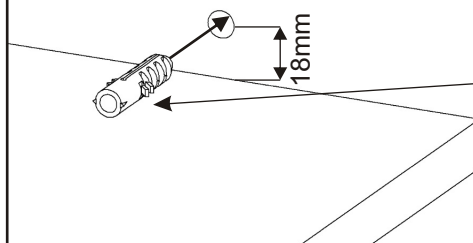

8.2.

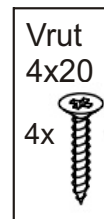
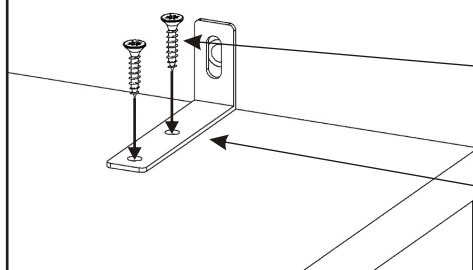

8.3.

