

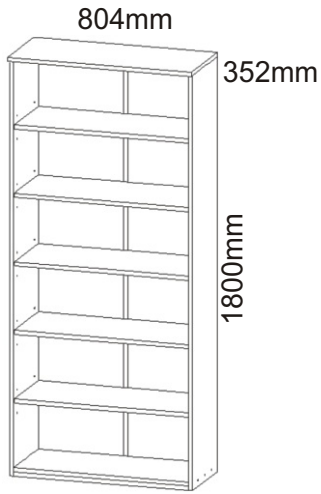







ALFA 10

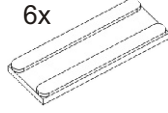

Policové podpěrky 20x 	Kluzáky 6x 	Lepidlo 1x 	Kolík 18x 
Hřebík 52x 	Konfirmát + krytky 6x 6x 	Vruty 4x30 6x 	H lišta 1746mm 1x 

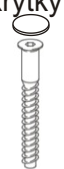
1.

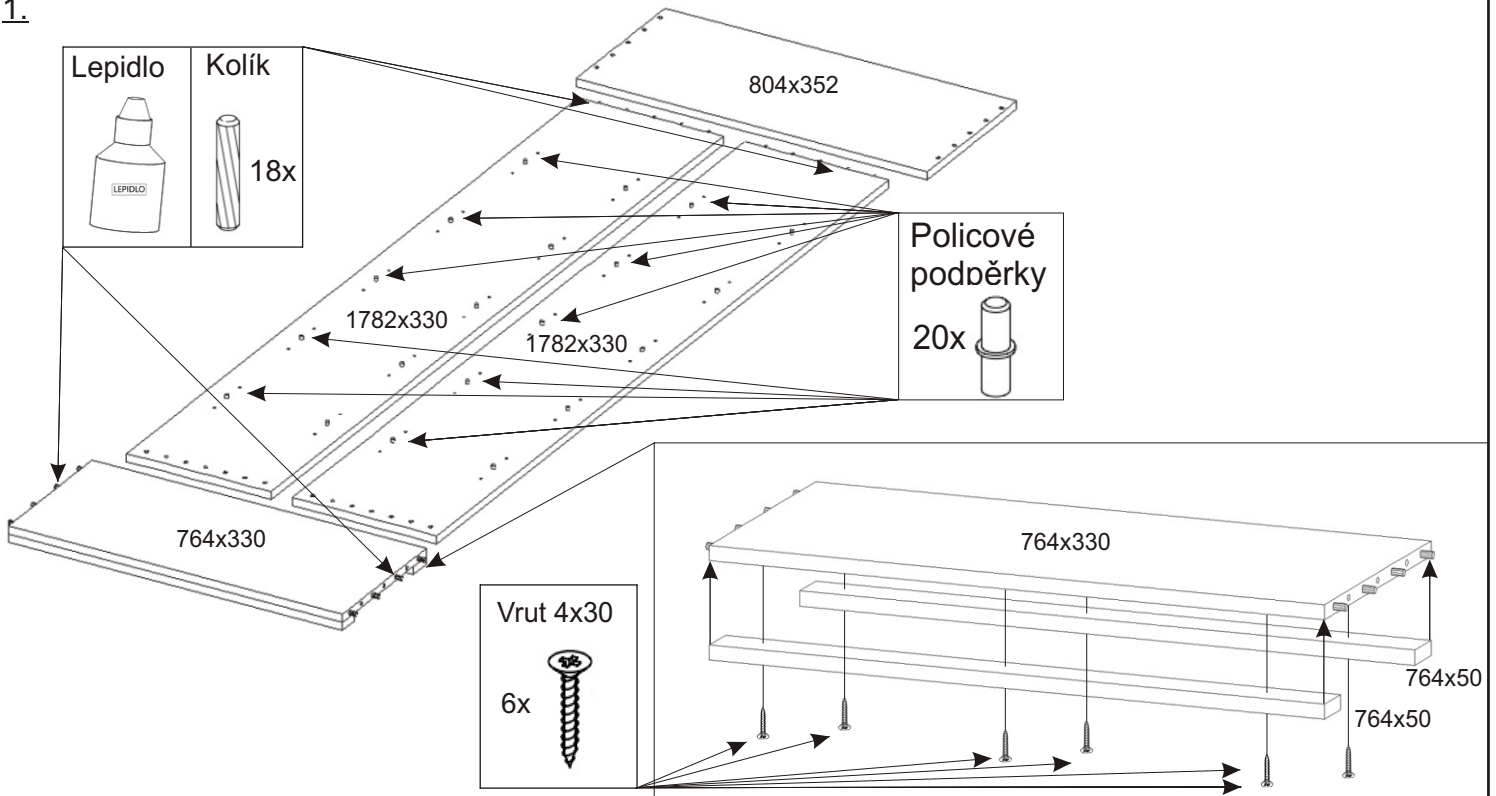

2.

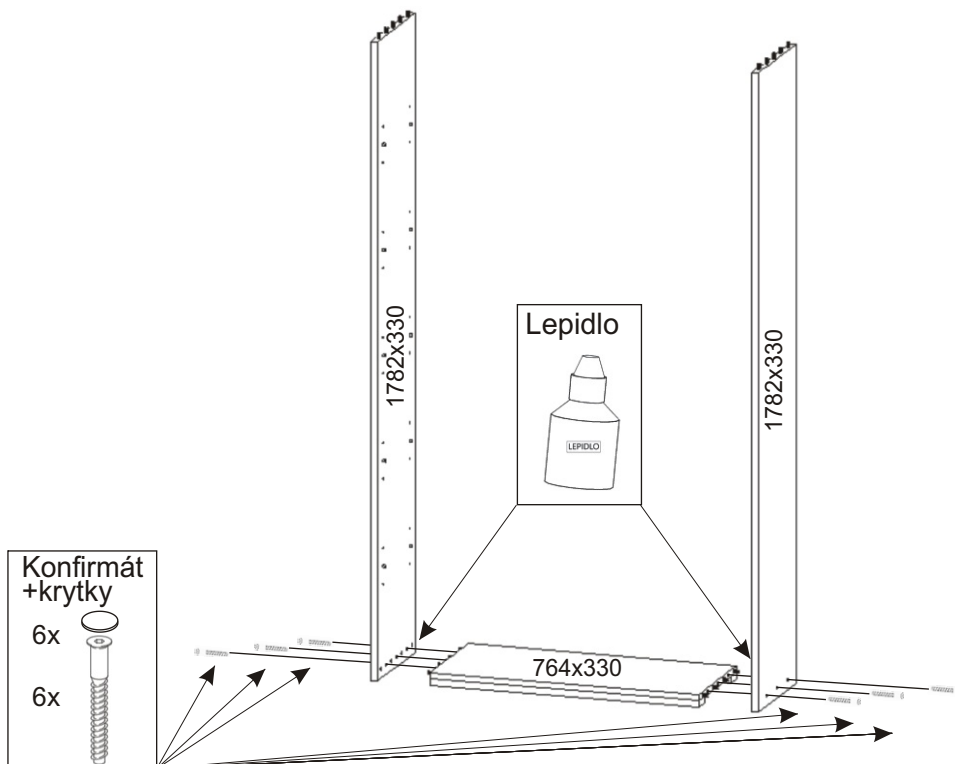

3.

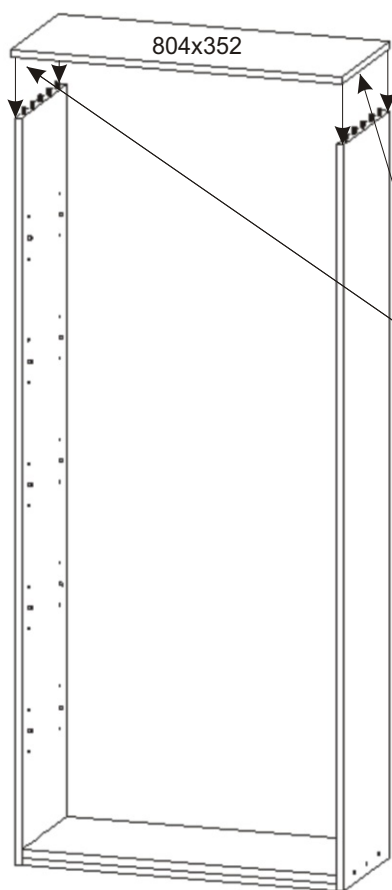

Lepidlo



4.

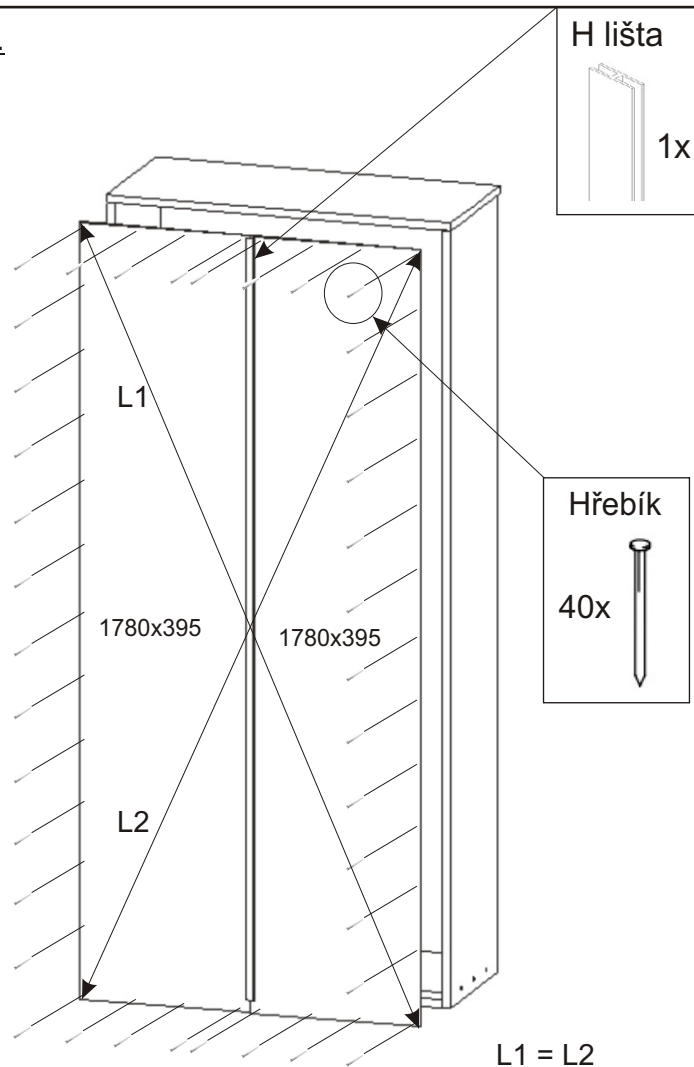

Hřebík

40x

L1 = L2

5.

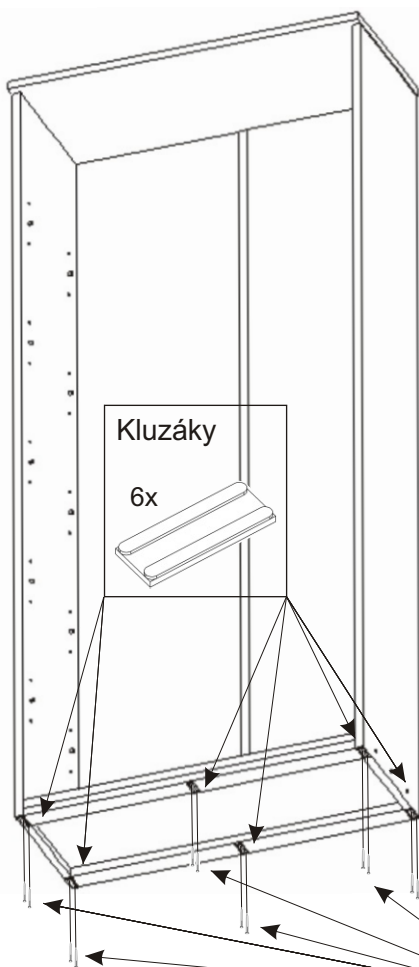

Kluzáky

6x

Hřebík

12x

6.

